

Operating Manual

PWS1-50K to 250K Series Energy Storage PCS



Sinexcel

PWS1-50K to 250K Series Bi-directional Energy Storage PCS

Operating Manual

Version: V2.1

Shenzhen Sinexcel Electric Co., Ltd.

All rights reserved. In case of any content change, it shall be without prior notice.

Shenzhen Sinexcel Electric Co., Ltd.

Website: <http://sinexcel.us/> or www.sinexcel.com

Add: Building 6, Area 2, Baiwangxin High-tech Industrial Park, No. 1002, Songbai Road, Nanshan District, Shenzhen

Postcode: 518055

Hotline: +86 0755-8651-1588

Table of Contents

1	Information on this Document	4
1.1	Validity	4
1.2	Target Group	4
1.3	Nomenclature Terms and abbreviations	5
2	Safety Precautions	6
2.1	Symbols	6
2.2	Important Safety instructions	6
2.3	Additional Information	7
3	Product Introduction	8
3.1	System Introduction	8
3.2	PCS Appearance	8
3.3	System Schematic Diagram	8
3.4	PCS Composition	11
3.5	Operating Compositions	13
3.5.1	Switches Introduction	13
3.5.2	Touch Screen	14
3.5.3	LEDs of the System	15
3.5.4	Labels	17
4	Technical Data	18
5	Storing, lifting and transporting	20
5.1	Safety during Transport	20
5.2	Transporting the PCS	20
5.2.1	Transport and storage	20
5.3	Unpacking the PCS	20
6	Installation	21
6.1	Safety during Installation	21
6.2	Mechanical Installation	22
6.2.1	Mounting preparation	22
6.2.2	Preparation for Mounting on a Base	23
6.3	Electrical Connections	24
6.3.1	Input requirement	24
6.3.2	Output requirement	24
6.3.3	Wiring mode	24
6.3.4	System grounding	30
6.3.5	DC port wiring	31
6.3.6	AC port wiring	31
6.3.7	Wiring of terminal strips	32
6.4	Communication interface connection	36
6.4.1	Connecting the EMS over RS485 or Ethernet	37
6.4.2	Connecting a BMS over CAN	38
6.5	Check after installation	38
7	Function Description	39
7.1	Operating Status	39
7.1.1	Overview of the Operating Status	39
7.1.2	Operating States without STS	40
7.1.3	Operating States with STS	41
8	Operation	42
8.1	Safety during Operation	42
8.2	Power On Procedure	42
8.3	Setting Procedure before startup	45
8.3.1	Touch screen power on	45
8.3.2	Log into the control Interface	45

8.3.3 Select Control Mode.....	45
8.3.4 General Settings.....	46
8.3.5 Communication setting	46
8.4 Manual Startup Procedure.....	46
8.5 Automatic Startup Procedure.....	47
8.6 Remote Startup Procedure.....	47
8.7 Shutdown Procedure.....	47
8.8 System Power Off.....	47
8.9 Emergency shutdown	47
9 Troubleshooting	48
9.1 Safety during Troubleshooting.....	48
9.2 Export fault record	48
9.3 Faults caused by improper parameter settings	48
9.4 Detailed Troubleshooting.....	49
10 Maintenance	50
10.1 Safety during Maintenance	50
10.2 Maintenance Schedule and Consumables.....	50
10.2.1 Operation environment requirements.....	50
10.2.2 Electrical and fixed connection inspection	51
10.2.3 Clearing and cleaning.....	51
10.3 Maintenance Work.....	51
11 Contact	52
Appendix 1 Settings on HMI (Touch Screen)	53
12.1 Touch Screen Startup	53
12.1.1 Main Menu Structure before log-in.....	53
12.1.2 Log into the control Interface	54
12.2 Main Menu Structure after log-in	55
12.3 Control Mode Setting	56
12.4 Parameter Setting	56
12.4.1 Settings Menu.....	56
12.5 Common Setting.....	62
12.5.1 Language Selecting	62
12.5.2 Date and Time Selecting.....	62
12.5.3 Communication setting	62
12.5.4 AC settings.....	62
12.5.5 DC settings	64
12.5.6 Regulating the reactive power of the ESS AC port in on-grid mode	65
12.6 System Setting.....	66
12.6.1 General Setting	66
12.7 Manual Startup	67
12.8 Automatic startup.....	68
12.9 Remote startup.....	68
12.10 Shutdown procedure	68
12.11 System Power Off.....	68
12.12 Emergency shutdown	69
Appendix 2 Limited Warranty Policy	70

1 Information on this Document

1.1 Validity

This document is valid for the following device models with or without STS module:

- PWS1-50K
- PWS1-50K-NA
- PWS1-50K-EX
- PWS1-100K
- PWS1-100K-NA
- PWS1-100K-EX
- PWS1-150K
- PWS1-150K-NA
- PWS1-150K-EX
- PWS1-250K
- PWS1-250K-NA
- PWS1-250K-EX

Model definition

This section introduces product model definition in this operating manual, as shown in Fig. 1-1:

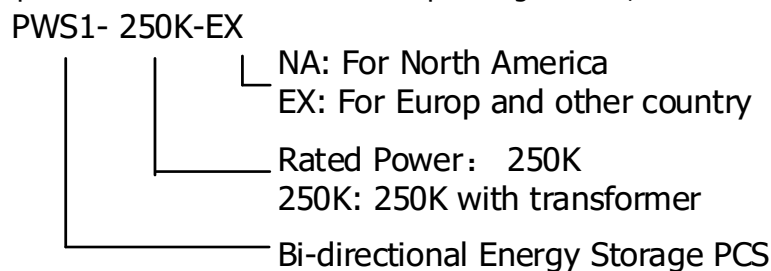

Fig.1-1 Product model definition

For example:

PWS1-250K: 250kW Bi-directional storage inverter with isolation transformer.

Check the type label for the production version of PCS.

The illustrations in this document have been reduced to be necessary and may differ from the real product.

1.2 Target Group

The tasks described in this document can only be performed by professionals or other qualified persons.

Qualified persons must have the following skills:





- Understand how the product works and how to operate the product
- Understand how the battery works and how to operate the battery
- Training on how to deal with the hazards and risks associated with installing and using electrical equipment installation
- Installation and commissioning of electrical equipment and installations
- Understand all applicable standards and directives
- Understand and follow this manual and all safety information

1.3 Nomenclature Terms and abbreviations

Terms	Definition
STS	Static Transfer Switch
AC	Alternative current.
DC	Direct current.
BESS	Battery energy storage system
ESS	Energy storage system.
EMS	Energy management system.
BMS	Battery management system.
PCS	Power conversion system.
SLD	Single line diagram
SOH	State of health (of battery), expressed in percentage.
SCR	Silicon controlled rectifier
DOD	Depth of discharge, the rest battery capacity, expressed in percentage.
EOD	End of discharging.
SOC	State of charge (of battery).
UI	User Interface
EPO	Emergency Power Off
SPD	Surge Protecting Device

2 Safety Precautions

2.1 Symbols

Symbol	Explanation
 DANGER	Indicates a dangerous situation that, if not avoided, will result in death or serious injury
 WARNING	Indicates a dangerous situation that, if not avoided, will result in death or serious injury
 CAUTION	Indicates a dangerous situation that, if not avoided, may result in minor or moderate injury
 NOTICE	Indicates that if property damage is not avoided
 NOTE	Draw attention to important information, best practices and tips NOTE is used to address information that is not related to personal injury, equipment damage, and environmental degradation.

2.2 Important Safety instructions

This user's manual is about installation and operation of Sinexcel PWS1 series 50kW to 250kW Bi-directional Energy Storage Inverter (PCS).

Before installation, please read this user's manual carefully.

The PCS must be commissioned and maintained by the engineers designated by the manufacturer or the authorized service partner. Otherwise, it might endanger personal safety and result in device fault. Any damage against the device caused thereby shall not be within the warranty scope.

The PCS cannot be used for any circumstance or application related to life support device.

This manual contains important instruction for Models of PWS1 series that shall be followed during installation and maintenance of the PCS.

DANGER

Any contact with copper bar, contactor and terminal inside the device or connected with the loop of utility grid might result in burning or fatal electric shock.

Don't touch any terminal and conductor connected with the loop of utility grid.

Pay attention to any instruction and safety documents about power on-grid.



WARNING

There might be an electric shock risk inside the device!

Any operation related to this device will be conducted by professionals.

Pay attention to the safety precautions listed in safety instruction and installation documents.

Pay attention to the safety precautions listed in operating and installation manual and other documents.



WARNING

Large leakage current

Before connecting input power supply, please ensure that the grounding is reliable.

The device must be grounded complying with the local electric codes.



WARNING

When storage battery is connected to PCS, there may be DC voltage at input port. Please pay attention to it during operation or check the battery system user manual



WARNING

Don't touch electric parts within 15 minutes after power outage!

There is dangerous energy in capacitance storage. Don't touch device terminal, contactor and cooper bar and other electric parts within 15 minutes after disconnecting all device power supplies.



NOTICE

All maintenance and preservation inside the device require using tools and shall be conducted by trained person. The components behind the protective cover plate and dam board which are opened by tools cannot be maintained by users.

Please read this user's manual before operation.

2.3 Additional Information

Links to additional information can be found at <http://sinexcel.us/> or www.sinexcel.com.

3 Product Introduction

3.1 System Introduction

The [PWS1 series 50K~250K Bi-directional Storage Inverter (PCS)] is a battery power conversion system that converts the DC (direct current) supplied by a battery into grid-compliant AC (alternating current). An [internal] low voltage transformer fitted downstream feeds the AC (alternating current) into the utility grid. This kind of PCS can be used in the on-grid mode and off-grid mode. The model with STS can get the faster switching between on-grid and off-grid mode.

The [PWS1 series 50K~250K Bi-directional Storage Inverter (PCS)] can be used in off-grid systems based on diesel generators (Gensets).

3.2 PCS Appearance

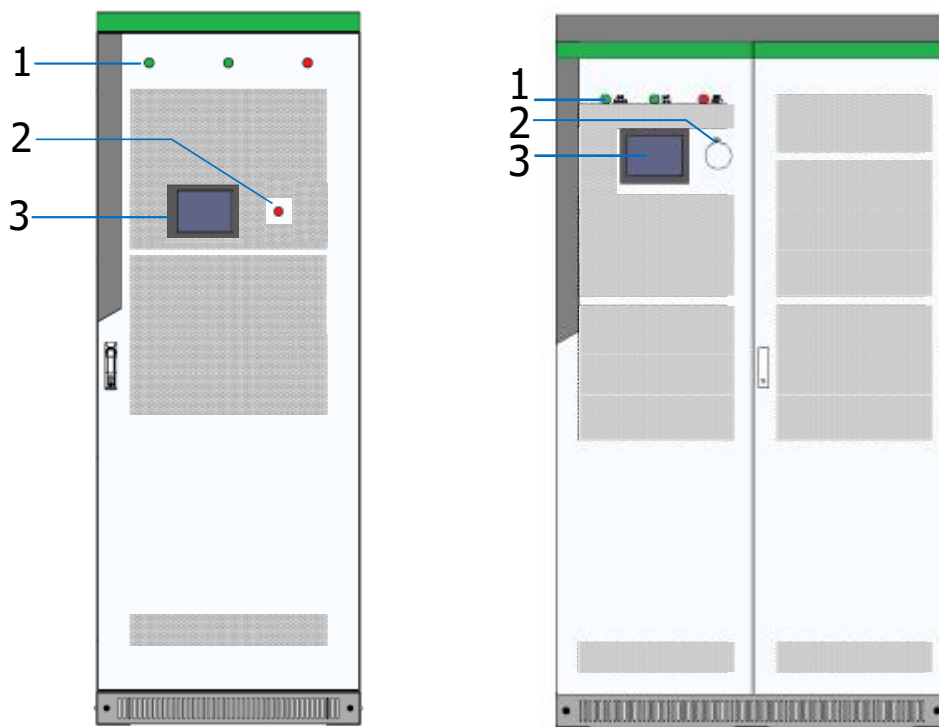

Figure3- 1: Design of the PCS

Position	Designation
1	Indicator light
2	EPO (Emergency Power Off)
3	HMI(Touch Screen)

3.3 System Schematic Diagram

PWS1-50K/100K/150K/250K Bi-directional Storage Inverter (PCS) is composed of 1 or multiple set(s) of PCS-AC modules. The modules identify master-slave systems through the DIP switch dial-up codes on the panel. #1 is a master system, while other modules track the master system. The Bi-directional Storage Inverter (PCS) cabinet is equipped with SPD protector, AC/DC breaker and distribution units. If on/off-grid

switching is to be achieved, extra power distribution unit needs to be added. Figure below is a topological graph for its composition and structure.

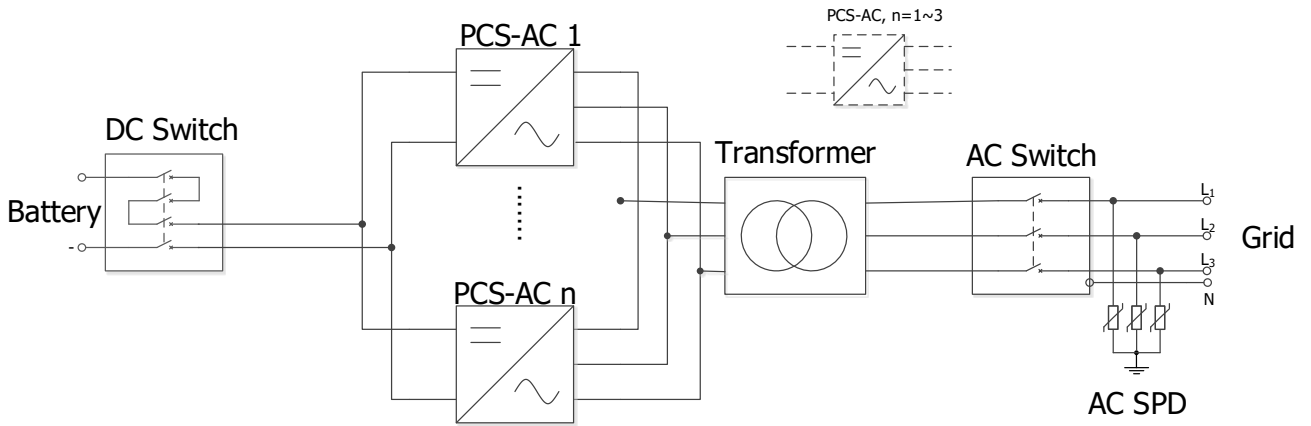

Fig. 3-2 Topological graph for PWS1-50K to 150K series Bi-directional Storage Inverter (PCS) without STS module

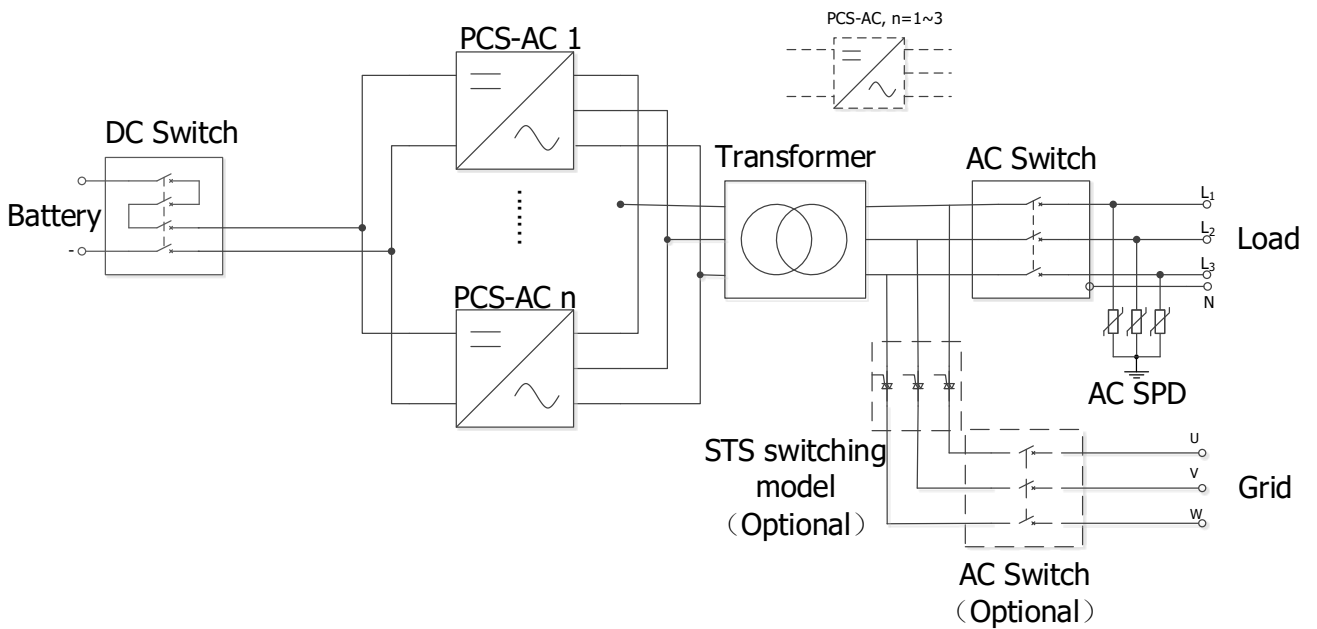

Fig. 3-3 Topological graph for PWS1-50K to 150K series Bi-directional Storage Inverter (PCS) with STS module

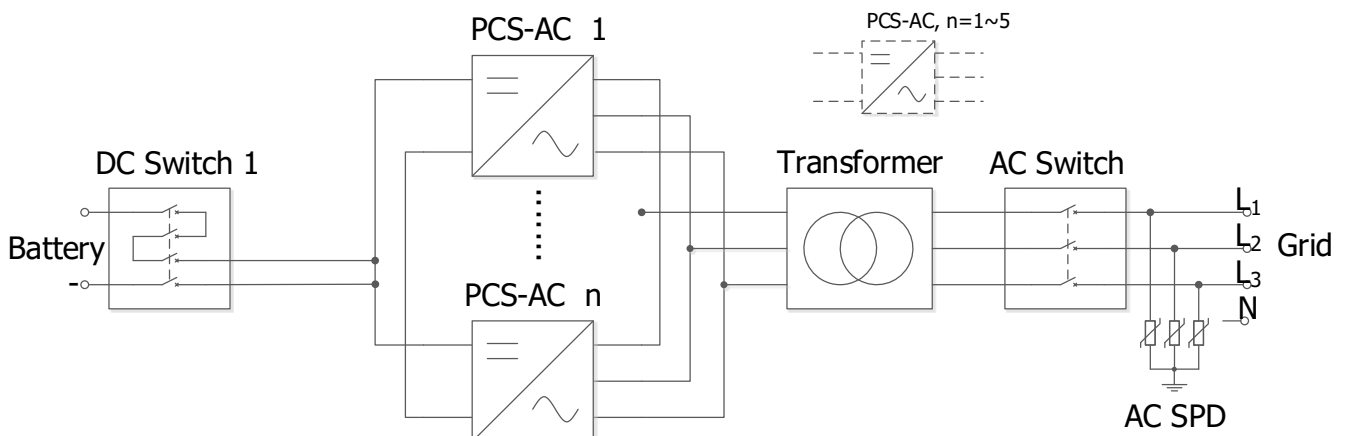

Fig. 3-4 Topological graph for PWS1-250K series Bi-directional Storage Inverter (PCS) with 1 branch input

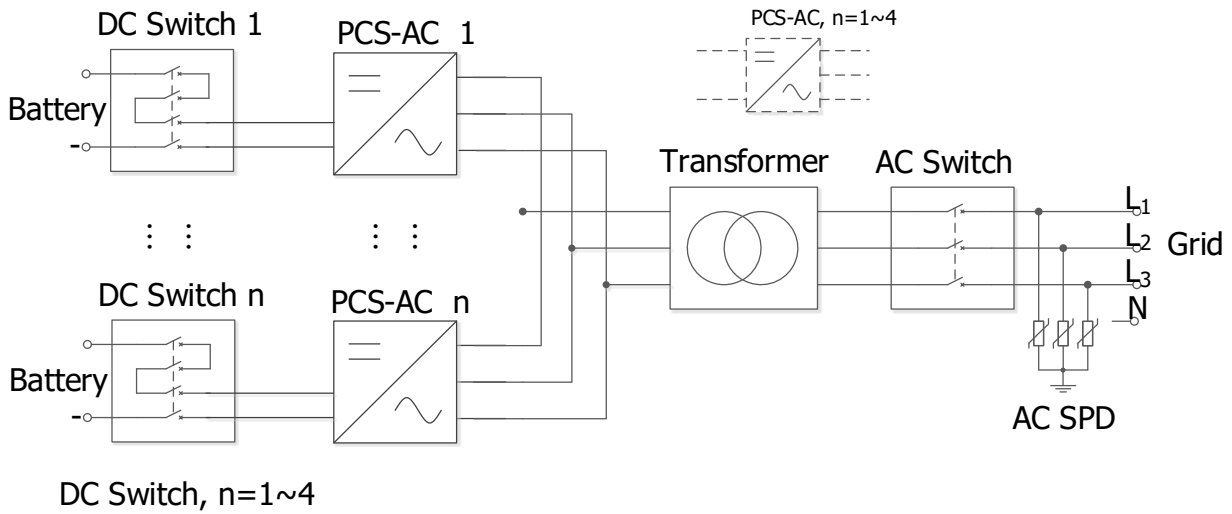

Fig. 3-5 Topological graph for PWS1-250K series Bi-directional Storage Inverter (PCS) with 4 branch input



NOTICE

Both models have identical mechanical and electrical construction except composed of different sets of PCS-AC modules and rating:

For PWS1-250K series is composed of 4 sets of PCS-AC modules, the special model with different number of DC branch switches from 1 to 4.

Main composition of PWS1-50K to 150K series PCS rack is shown in Table.3-2.

Table 3-2 Main composition of the PCS rack

Serial No.	Item	Quantity	Remark
1	Cabinet	set	The cabinet is equipped with distribution components.
2	PCS-AC module	1~3set(s)	50Kw 1 set; 100Kw 2 sets; 150Kw 3 sets;
3	Isolation transformer	1set	
4	Power Management Unit	1 set	It is installed in the cabinet door.

Main composition of PWS1-250K series PCS rack is shown in Table.3-2.

Table 3-3 Main composition of the PCS rack

Serial No.	Item	Quantity	Remark
1	Cabinet	set	The cabinet is equipped with distribution components.
2	PCS-AC module	5 set(s)	4 sets for the 4 branch DC input switch model;
3	Isolation transformer	1set	
4	Power Management Unit	1 set	It is installed in the cabinet door.

3.4 PCS Composition

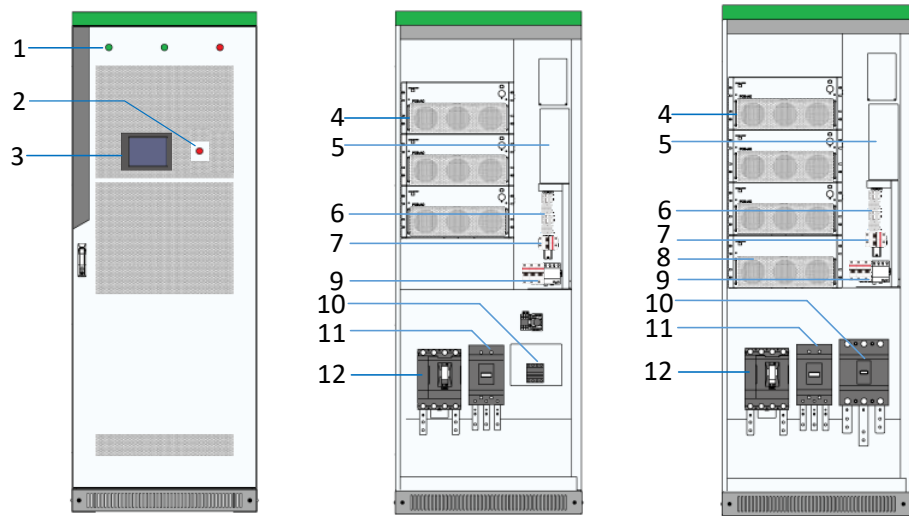
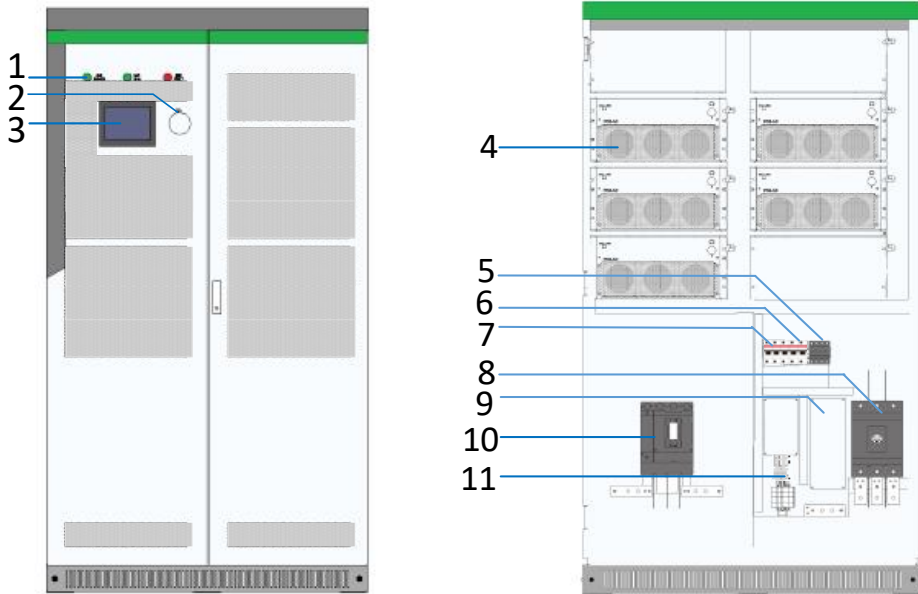

Figure3-6: Visible Components of the PCS without STS module with STS module
For PWS1-50K to 150K series

Position	Designation	Description
1	Indicator lights	
2	EPO (Emergency Power Off)	
3	Touch Screen	
4	PCS-AC (1~3 module(s))	50KW 1 set; 100KW 2 sets; 150KW 3 sets;
5	U2 Main Control Board	
6	Wiring Terminal	Digital Input and Digital Output
7	AUX power supply switch	
8	STS module	Switching device; Only for the models with STS
9	SPD switch	
10	Manual Soft Start Switch	Only for the models without STS
Or	AC breaker (Grid)	Only for the models with STS
11	AC breaker (Grid)	Only for the models without STS
Or	AC breaker (Load)	Only for the models with STS
12	Battery switch	

Components position 6 Wiring Terminal, 7 AUX power supply switch, 9 SPD switch, can be seen after unfold the dam-board.



without STS module

Figure3-7: Visible Components of the PCS
For PWS1-250K series

Position	Designation	Description
1	Indicator lights	
2	EPO (Emergency Power Off)	
3	Touch Screen	
4	PCS-AC (1~5 module(s))	62.5KW 1 set
5	Manual Soft Start Switch	Only for the models without STS
6	AUX Power supply switch	
7	SPD switch	
8	AC Switch	
9	U2 Main control board	
10	Battery DC Branch Switch	1 to 4 set DC Branch Switch
11	Wiring terminal	

Components position 6 AUX power supply switch, 7 SPD switch, 11 Wiring Terminal can be seen after unfold the dam-board.

3.5 Operating Compositions

3.5.1 Switches Introduction

3.5.1.1 AC switch

The AC disconnection unit disconnects the PCS from the Grid. The NA series PCS breaker is comply to the UL certification.

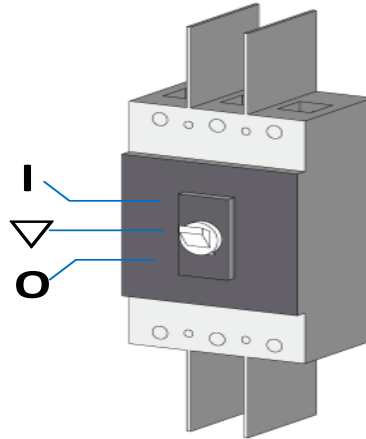

Figure 3-8: Switch positions of the AC disconnection unit

Position	Designation	Explanation
I	Switch position In (On)	The AC disconnection unit is closed.
▽	Central switch position	The AC disconnection unit was tripped and is open.
O	Switch position off	The AC disconnection unit is open.

3.5.1.2 DC Switch

The DC disconnection unit disconnects the PCS from the Battery module arrays. The NA series PCS breaker is comply to the UL certification.

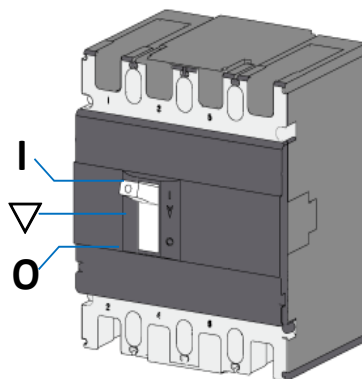

Figure 3-9: Indicators on the DC load-break switch

Position	Designation	Explanation
I	Switch position In (On)	The DC disconnection unit is closed.
▽	Central switch position	The DC disconnection unit was tripped and is open.
O	Switch position off	The DC disconnection unit is open.

3.5.1.3 AUX power supply AC Switch

220Vac AUX power supply can be the redundancy power supply through the AC Switch inside the PCS cabinet. These switches can be visible after opening the dam-board.

AUX power supply switch

SPD switch

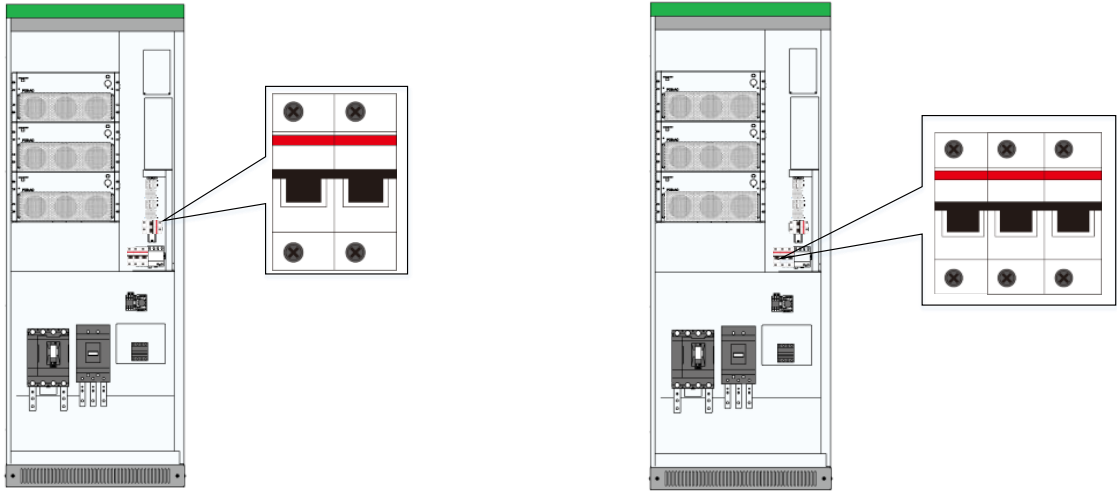

Figure 3-10: PWS1-50K/100K/150K AUX power supply AC Switch and SPD switch

AUX power supply switch

SPD switch

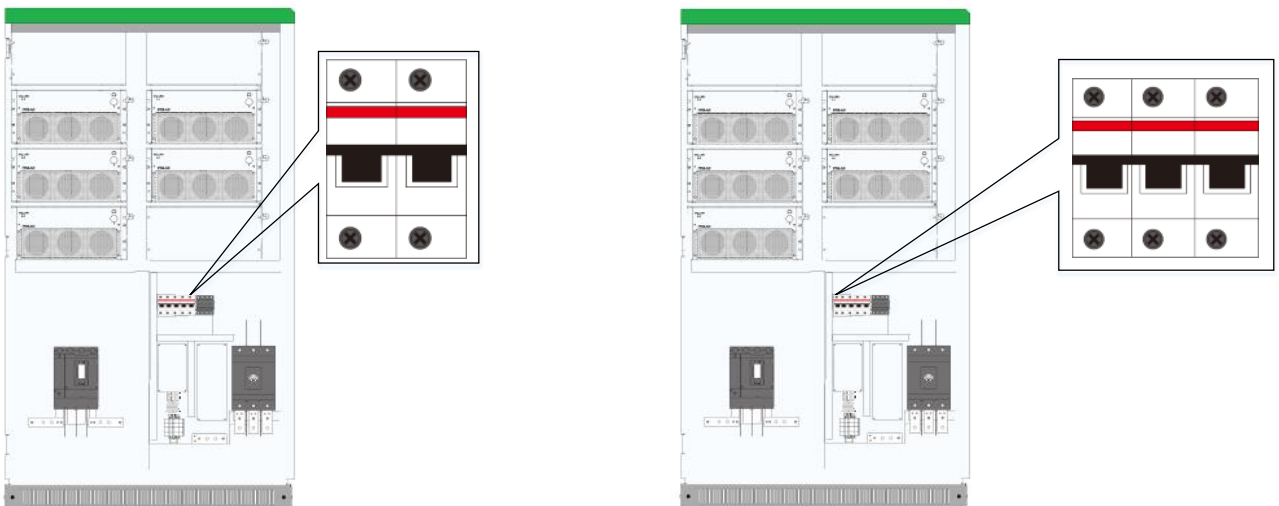

Figure 3-11: PWS1-250K AUX power supply AC Switch and SPD switch

3.5.2 Touch Screen

3.5.2.1 User Interface

The touch display is used to display instantaneous values and parameter settings. Click the touch screen with fingernail. Tapping the symbols on the touch display activates the corresponding functions. If the touch display has not been touched for **【ten】** minutes, the display is locked and the logged-in user will be logged

out. By tapping the screen unlock the display again.

The touch display is divided into two areas.

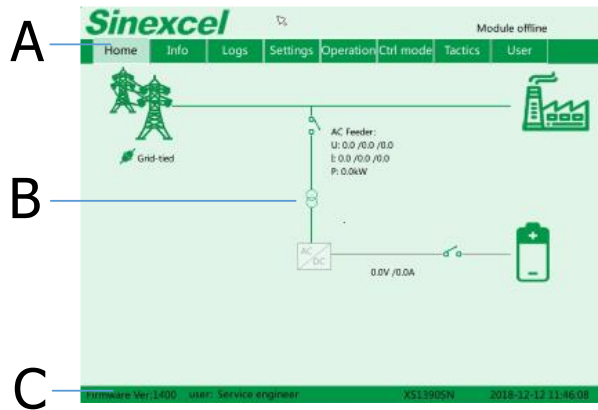

Figure 3-12 UI Design of the touch display

Position	Designation	Explanation
A	Menu	Menu can be different before/after log-in and other setting.
B	System Topology	
C	Version and time	

3.5.2.2 Symbols Explanation

Symbol	Designation
	Grid
	Load in AC side
	DC side
	STS Module
	Transformer (Inside)
	AC Module
	Switch on DC or AC side open
	Switch on DC or AC side closed

3.5.3 LEDs of the System

The appearance of the PCS is shown in below. Front door body is mainly composed of touch screen, normal indicator light, alarm indicator light and emergency shutdown button etc.

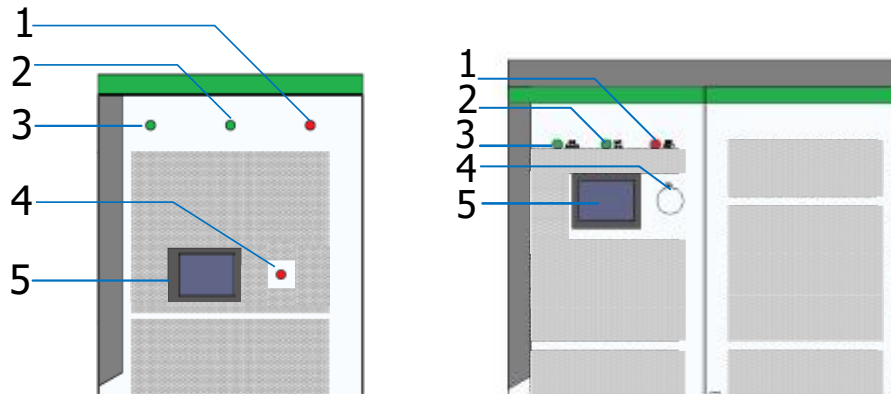

Figure 3-13 LEDs on the front panel

LED designation	Description	Explanation
1	Fault indicator light	
2	Normal indicator light	
3	Power indicator light	
4	Emergency shutdown button	
5	Touch screen	

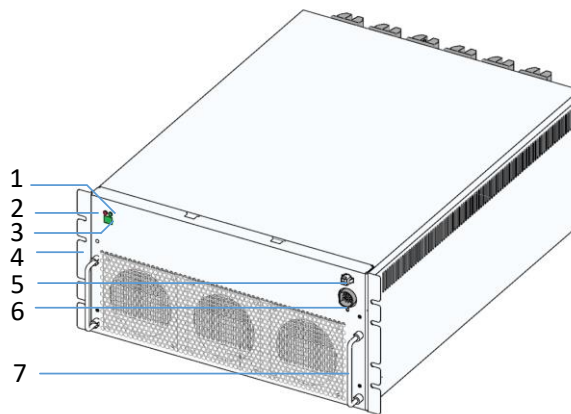

Figure 3-14 Front view for PCS-AC module

LED designation	Description	Explanation
1	Normal indicator light	Green
2	Fault indicator light	Red
3	DIP switch	Address
4	Hanger	
5	Power supply socket	
6	Communication cable socket	
7	Handle	Can't bearing too much weight

3.5.4 Labels

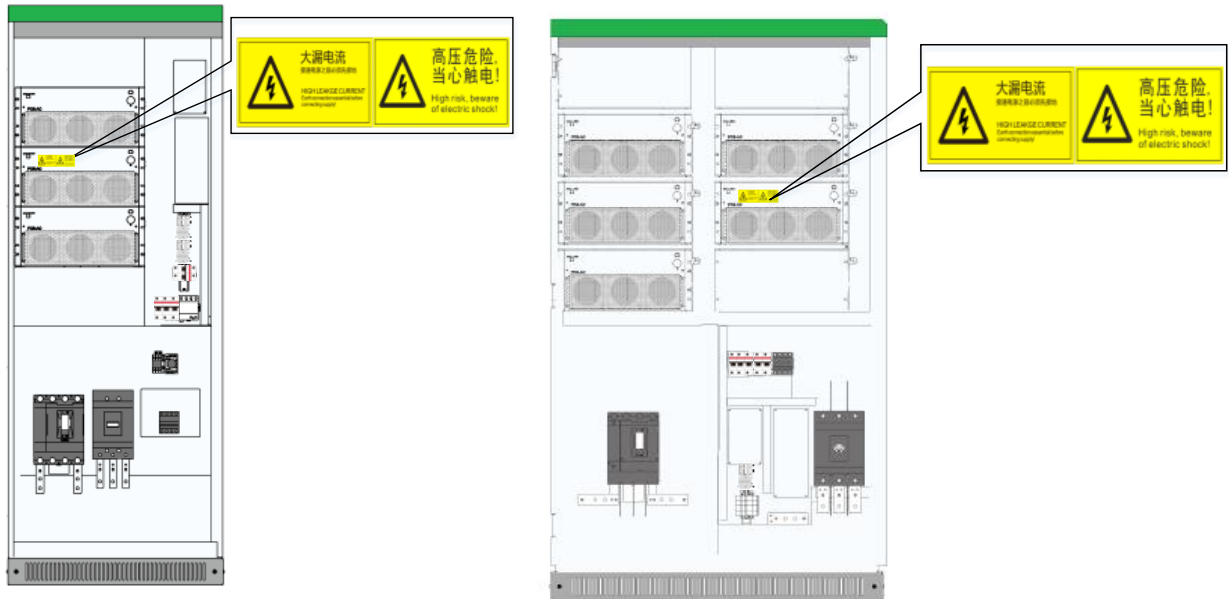











Figure 3-15 Warning label position

No.	Label	Explanation
1		Label-Dot label-A phase
2		Label-Dot label-B phase
3		Label-Dot label-C phase
4		Label-Dot label-Negative electrode
5		Label-Dot label-Negative electrode
6		Label-Dot label-Negative electrode
7		Label-Dot label-Neutral line
8		Label-Dot label-Grounding
9		Label-Warning label-Danger High Voltage
10		Label-Warning label-Danger large leak current

4 Technical Data

Technical parameters for the models with transformer

Model	PWS1-50K	PWS1-100K	PWS1-150K	PWS1-250K
Utility-interactive Mode				
Battery voltage range	500~850V	500~850V	500~850V	500~850V
DC max current	110A	220A	330A	550A
Quantity of battery strings	1/4/8			
AC voltage	480V(423V~528V)	480V(423V~528V)	480V(423V~528V)	480V(423V~528V)
AC current	60A	120A	180A	301A
Nominal power	50kW	100kW	150kW	250kW
AC frequency	60Hz(59.5~60.5Hz)			
THDi	≤3%			
AC PF	Listed: 0.8~1 leading or lagging (Controllable) Actual: 0.1~1 leading or lagging (Controllable)			
Stand-alone Mode				
Battery voltage range	500~850V	500~850V	500~850V	500~850V
DC Max Current	110A	220A	330A	550A
AC output voltage	480V(±10% configurable)			
AC output current	60A(Max 66A)	120A(Max 132A)	180A(Max 198A)	301A(Max 331A)
Nominal AC output power	50kW	100kW	150kW	250kW
AC max power	55kW	110kW	165kW	275kW
Output THDu	≤2% (Linear load)			
AC frequency	60Hz			
AC PF	Listed: 0.8~1 leading or lagging (Load-depend) Actual: 0.1~1 leading or lagging (Load-depend)			
Overload Capability	105%~115% 10min; 115%~125% 1min; 125%~150% 200ms			
Physical				
Cooling	Forced air cooling with replaceable fan module			
Noise	70dB			
Enclosure	IP20/NEMA1	IP20	IP20	IP20
Max elevation	3000m/10000feet (> 2000m/6500feet derating)			
Operating ambient	-20°C to 50°C (De-rating over 45°C)			

temperature				
Humidity	0~95% (No condensing)			
Size (W×H×D)	800*2160*800mm	800*2160*800mm	800*2160*800mm	1200*2160*800mm
	31.5*85*31.5 inches	31.5*85*31.5 inches	31.5*85*31.5 inches	47.2*85*31.5 inches
Weight	465kg	680kg	910kg	1280kg
Installation	Vertical installation			
Other				
Peak efficiency	95.50%	95.80%	96.10%	96.10%
CEC efficiency	94%	94%	94.5%	95%
Protection	OTP, AC OVP/UVP, OFP/UFP, EPO, AC Phase Reverse, Fan/Relay Failure, OLP, GFDI, Anti-islanding			
Configurable protection limits	Upper/Lower AC Voltage/Frequency limit, Battery EOD voltage.			
AC connection	3-Phase 4-Wire+PE			
Display	Touch Screen			
Communication	RS485,CAN,Ethernet			
Isolation	Built-in Transformer			
Certification	ETL listed conforming to UL1741/UL1741SA, UL9540, CPUC RULE 21, IEEE1547, HECO RULE14H, CEC, CSA22.2, HECO CGS, HECO CSS			

Application environment restrictions:

When the Battery Energy Storage System is working in stand-alone mode (off-grid mode), there are some restriction to the application environment.

- Several PCS AC output parallel is the customized function. Please contact manufacture when user need the AC output parallel in off-grid mode.
- Resistive load power < PCS rated power
- RCD (Resistive Capacitor Diode) load power < PCS rated power * 80%, and meanwhile RCD load power<100KW. When the RCD load >100KW, please contact the manufacture and customize the PCS.
- Motor load with Frequency Converter, load power < PCS single machine rated power * 80%
- Motor load without Frequency Converter, please contact the manufacture and customize this PCS function.

5 Storing, lifting and transporting

More detailed shipping and installation information can be found in the Installation Manual.

5.1 Safety during Transport



WARNING

If the lifted or suspended load falls over, falls or sways, there is a risk of crushing. Vibration or careless or hasty lifting and transport can cause the product to tip over or fall. This can result in death or serious injury.

All national transport standards and regulations must be respected.

Always transport the product as close as possible to the floor.

Avoid fast or uneven movement during transport.

Always maintain a sufficient safety distance from the product during transportation.



NOTICE

Damaged frame structure of the PCS due to uneven support surface

Placing the PCS on an uneven surface can cause bending, which causes the PCS door to no longer close properly. This can cause moisture and dust to seep into the PCS.

Do not place the PCS on an unstable, uneven surface, even for short periods of time.

The unevenness of the support surface must be less than 0.25%.

Do not use the installed kick plate to transport the PCS.

5.2 Transporting the PCS

5.2.1 Transport and storage

The module of the PCS are installed in the PCS cabinet rack during shipping. During device transport and storage, pay attention to the caution sign on the packing case.

The selection of storing position should ensure that:

- There is no corrosive gas around it.
 - There are over-wetting and high-temperature sources.
 - It is not a dusty environment.
 - It complies with the local firefighting requirements.
-



NOTICE

During rack transport and storage, stacking is not allowed. The device top cannot be placed with other articles.

The rack should be placed vertically at forward direction. Don't keep it upright placed horizontally.

5.3 Unpacking the PCS

More detailed Transporting Unpacking the PCS can be found in the Installation Manual.

6 Installation

More detailed shipping and installation information can be found in the installation manual.

6.1 Safety during Installation



DANGER

Risk of electric shock caused by live voltage

There is a high voltage in the live components of the product. Touching field components can result in death or seriousness electric shock damage.

Wear appropriate personal protective equipment for all work on the product.

Do not touch any live components.

Observe all warning messages in products and documents.

Obey all safety information from the battery manufacturer.



DANGER

Electric shock hazard caused by DC cable

The DC cable connected to the battery is live. Contact with live cables can cause electrocuted death or serious injury shock.

Before connecting the DC cable, make sure that the DC cable has no voltage.

Wear appropriate personal protective equipment for all work on the product.



WARNING

Danger to life due to electric shock when entering the storage system

Damage to the insulation in the storage system can result in fatal ground currents. May cause a fatal electric shock. Ensure that the insulation resistance of the storage system exceeds the minimum.

Minimum value: The insulation resistance is: 14kΩ.

The PCS must be installed in a closed electrical operating area.



WARNING

Fire due to failure to observe torque specifications at real-time bolt connections

Failure to comply with the specified torque reduces the current carrying capacity of the live bolt connection, thereby reducing the contact resistance increase.

This can cause the components to overheat and catch fire.

Be sure to always tighten the live bolt connection using the exact torque specified in this document.

Use only the right tools when working on the device.

Avoid repeatedly tightening the live bolt connection as this may result in unacceptably high torque.

6.2 Mechanical Installation

6.2.1 Mounting preparation

Drilling Mounting Holes is required in the Foundation. The overall dimension of the PCS is shown in figure below.

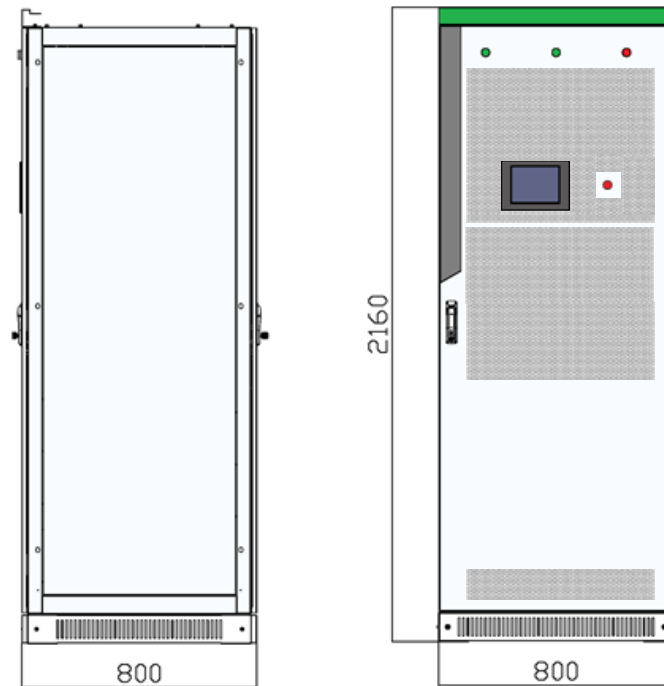

Fig. 6-1 Overall dimensions of PWS1-50K to 150K

The PWS1-50K to 150K series cabinet, width: 800mm, height: 2,160mm (without lifting rings); depth: 800mm.

The height of the green lintel is 60mm and it can be taken down if there is no sufficient height into the room. The PWS1-50K to 150K series Bi-directional Storage Inverter is without lifting rings and can't lift.

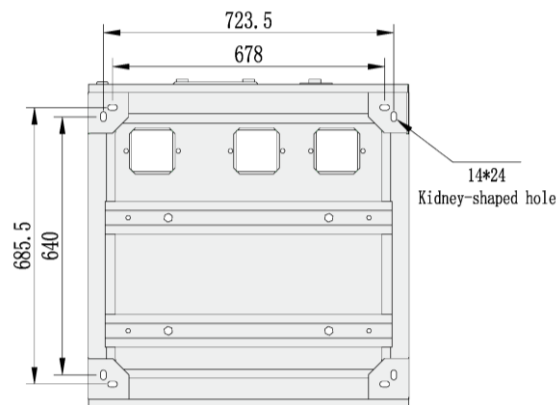

Fig. 6-2 PWS1-50K to 150K wiring hole in bottom view

There are two hole in each corner, only one hole need to mount bolts, the other hole is used as a spare.

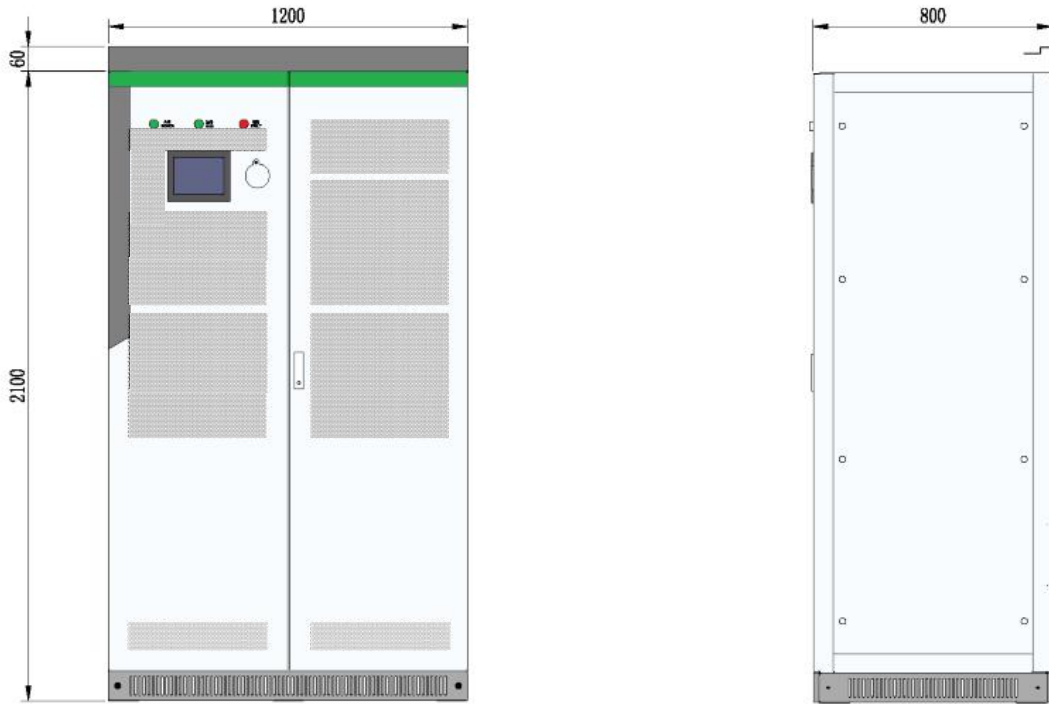

Fig. 6-3 Overall dimensions of PWS1-250K

The PWS1-250K series cabinet, width: 1200mm, height: 2,100mm (without lifting rings); depth: 800mm. The height of the lintel is 60mm and it can be taken down if there is no sufficient height into the room. The PWS1-250K series Storage Inverter is without lifting rings and can't lift.

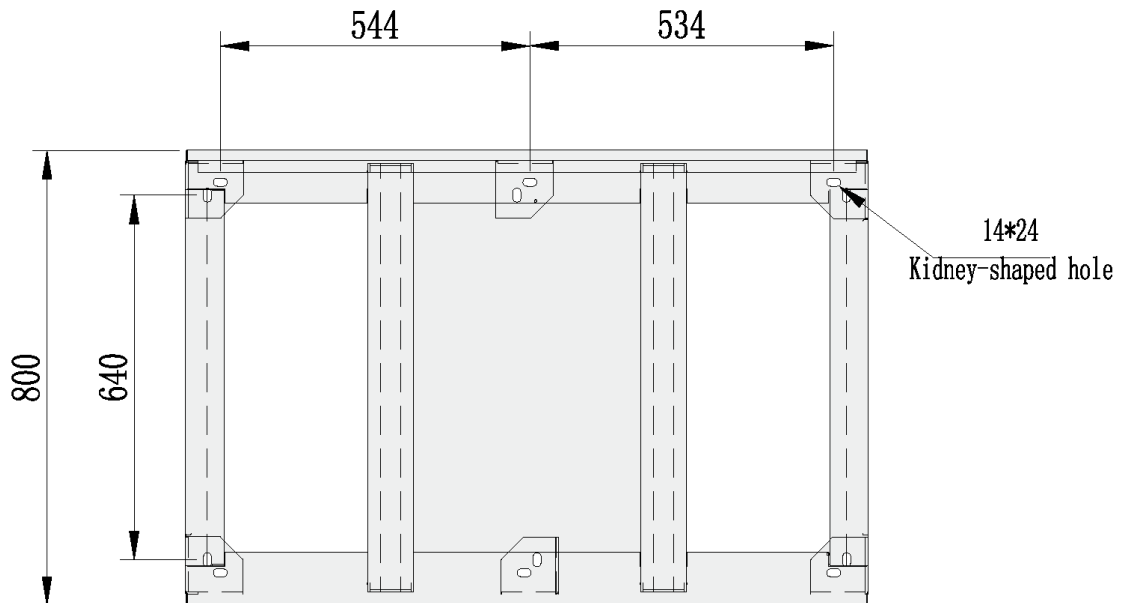

Fig. 6-4 PWS1-250K rack wiring hole in bottom view

There are two hole in each corner, only one hole need to mount bolts, the other hole is used as a spare.

6.2.2 Preparation for Mounting on a Base

After the rack is removed to the installation position of BESS (battery energy storage system) with a forklift or a tool. Fine adjust the rack and remove it to the designed position, open the internal door of rack, use M10 or M12 screw to fix the rack.

When the rack needs to be fixed on the steel channel, $\Phi 14$ holes can be made in the steel channel. Fix the rack to the steel channel with screws.

When the rack is fixed to the concrete floor, make holes on the floor and fix the rack to the concrete floor with expansion screws.

For the detailed mounting on a base, please see the Installation Manual.

6.3 Electrical Connections

6.3.1 Input requirement

DC voltage of the PCS should be within the input voltage range, or the PCS will be unable to operate. When configuring the quantity of batteries in each string, the maximum charging voltage and minimum discharging voltage should be fully considered. For details, please consult our technical person.

The battery system working with the PCS should be equipped with DC switch and is recommended to be certified by CSA E61233 or UL1973. And the charging/discharging voltage should be between the input voltage range. It should also be equipped with DC air switch and the BMS certified by CSA No. 0.8 or UL991+UL1998. While connecting with external battery pack, please make sure DC and AC switches are disconnected.



NOTICE

For the multi-string models. Every DC input circuit branch in PCS should be able to operate independently. For multi-string models (e.g. PWS1-500KTL-XX), each DC input is independent from the other and should be connected with individual battery system. The batteries need to be connected to each branch port.

6.3.2 Output requirement

The output of the PCS is 3-phase and 4-wire. When designing energy storage system, the PCS has been equipped with an isolation transformer, the voltage of its output side can directly be connected to the low-voltage utility grid.

6.3.3 Wiring mode

The wiring mode of the PCS is down inlet and down outlet, the incoming and outlet wiring holes located in bottom of the PCS cabinet. The cables put into the cable trough via the wire holes at the base. Open the front door and dismantle the dam-board to see wiring of the copper bars. As for wiring requirements, single cables or multiple cables with proper wire diameter should be selected. It is suggested that the current in 1mm^2 wire should be $\leq 3\text{A}$.

The wiring methods should be in accordance with the National Electrical Code or other local standards, ANSI/NFPA 70 are to be used for NA version.

Open the dam-board of back door and then can see the wiring copper bar as shown below.

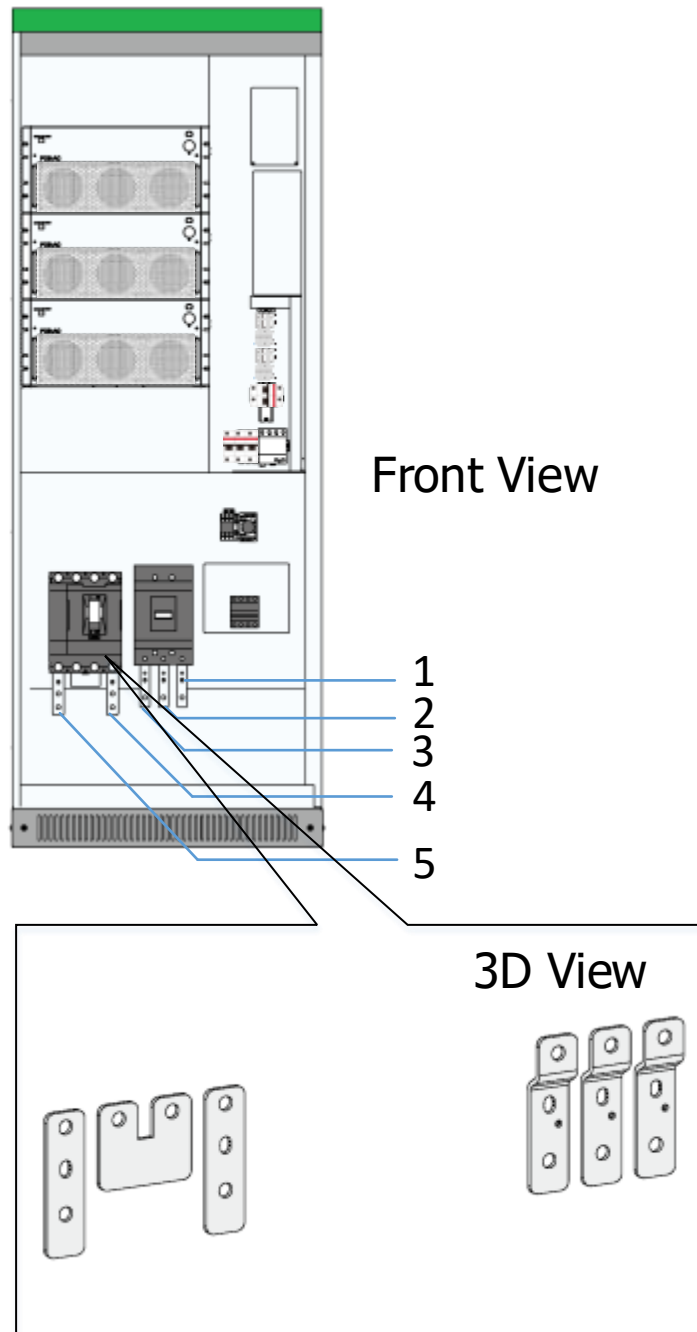

Fig. 6-5 PWS1-50K to 150K series wiring copper bars designation without STS module

Table 6-1 PWS1-50K to 150K series wiring copper bars description

Position	Designation	Description
1	C	Phase C, dimension is shown as below.
2	B	Phase B
3	A	Phase A
4	Battery -	Battery negative port
5	Battery +	Battery positive port

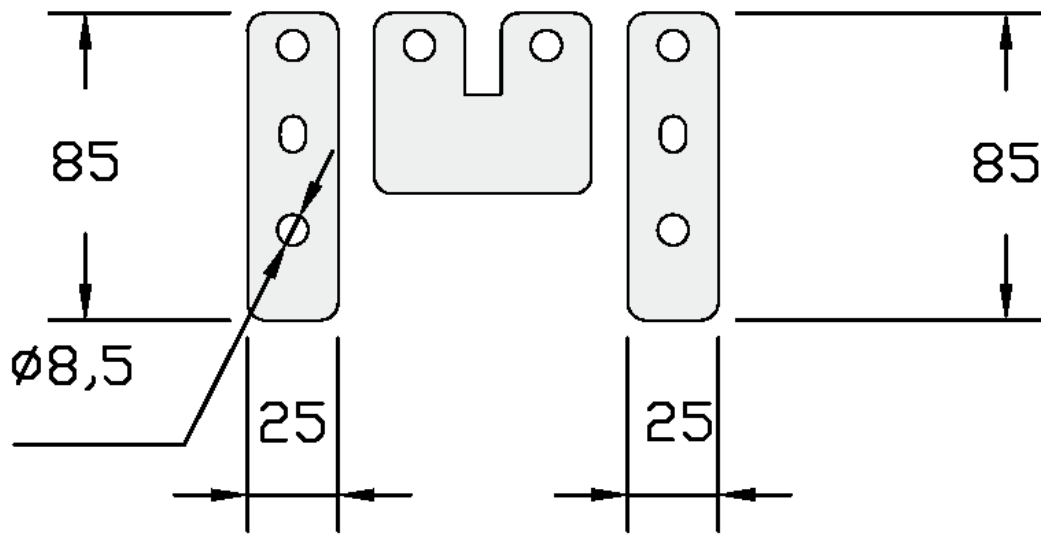

Fig. 6-6 PWS1-50K to 150K series DC wiring copper bar dimension

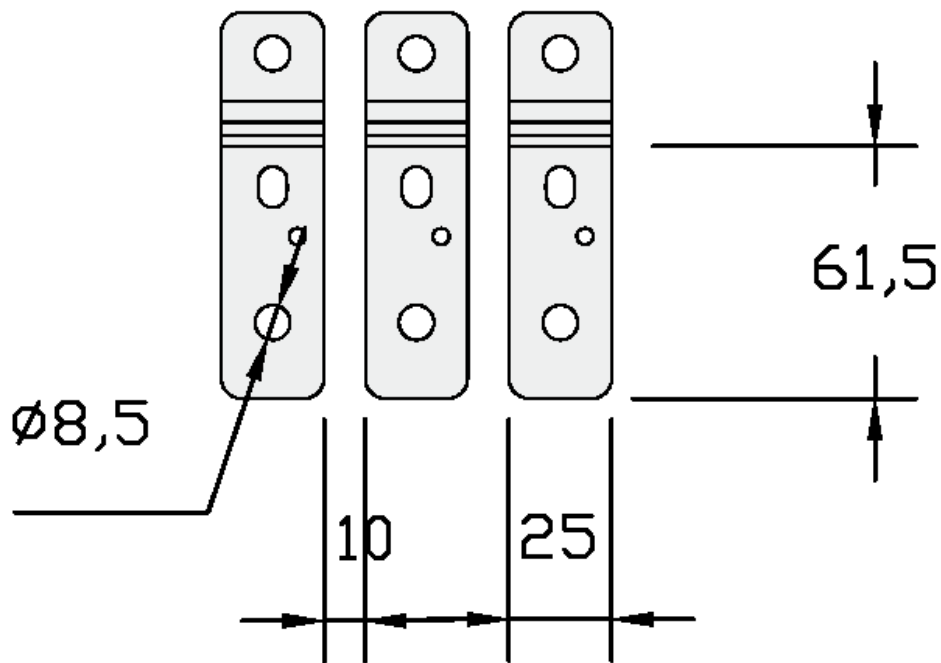

Fig. 6-7 PWS1-50K to 150K series AC wiring copper bars dimension

Open the dam-board of back door and then can see the wiring copper bar as shown below.

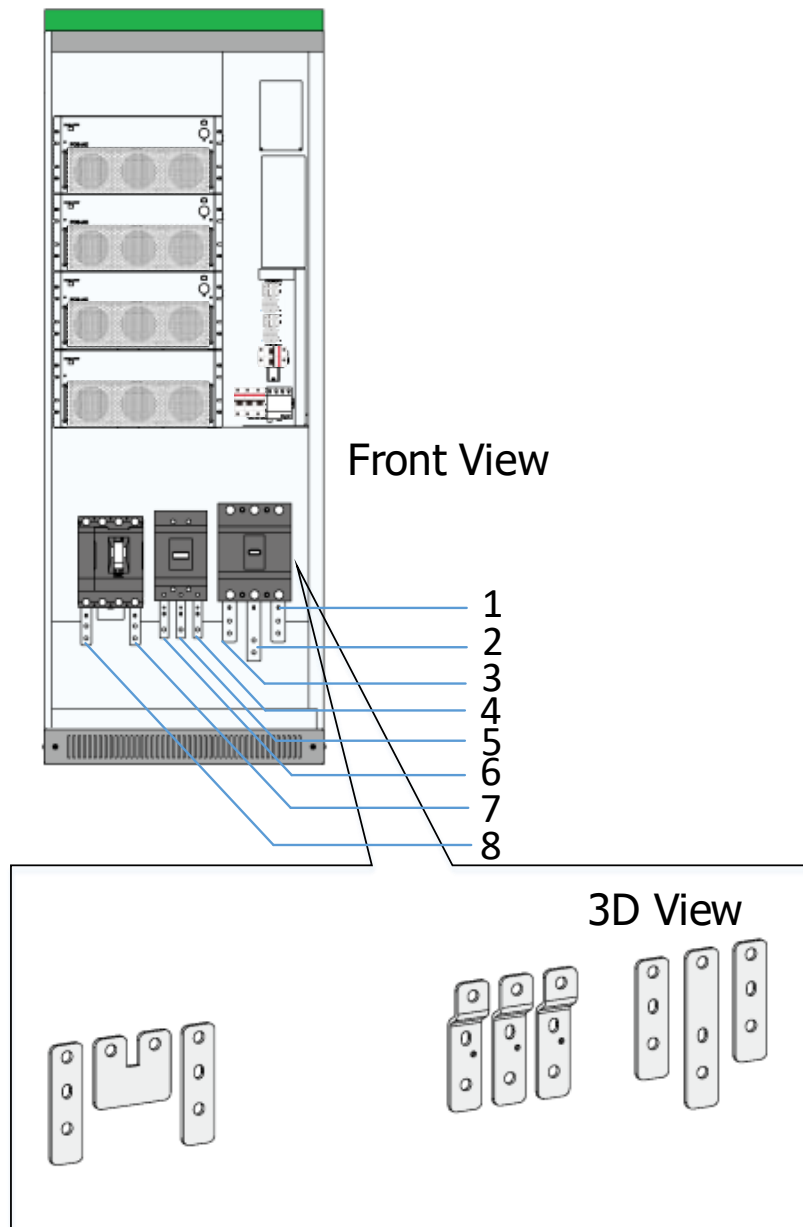

Fig. 6-8 PWS1-50K to 150K series wiring copper bars designation with STS module

Table 6-2 PWS1-50K to 150K series wiring copper bars description

Position	Designation	Description
1	C(grid)	Phase C, dimension is shown as below.
2	B(grid)	Phase B
3	A(grid)	Phase A
3	C(load)	Phase C, dimension is shown as below.
4	B(load)	Phase B
5	A(load)	Phase A
7	Battery -	Battery negative port
8	Battery +	Battery positive port

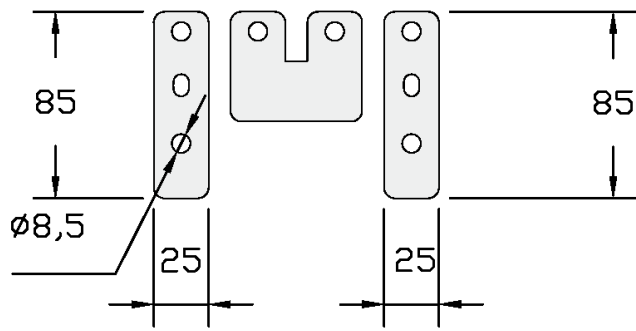

Fig. 6-9 PWS1-50K to 150K series DC wiring copper bar dimension

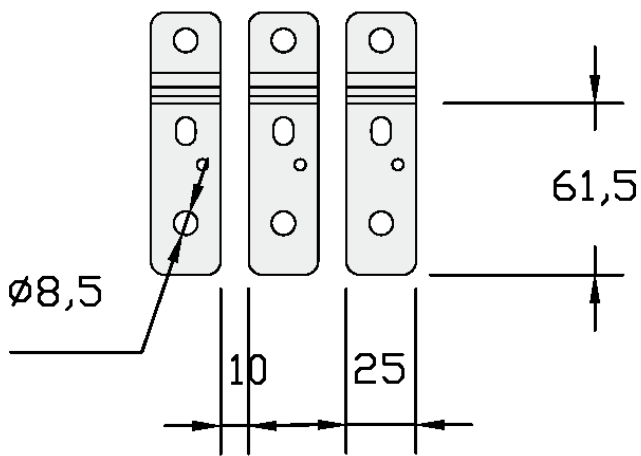

Fig. 6-10 PWS1-50K to 150K series with STS module AC wiring copper bars dimension for Load

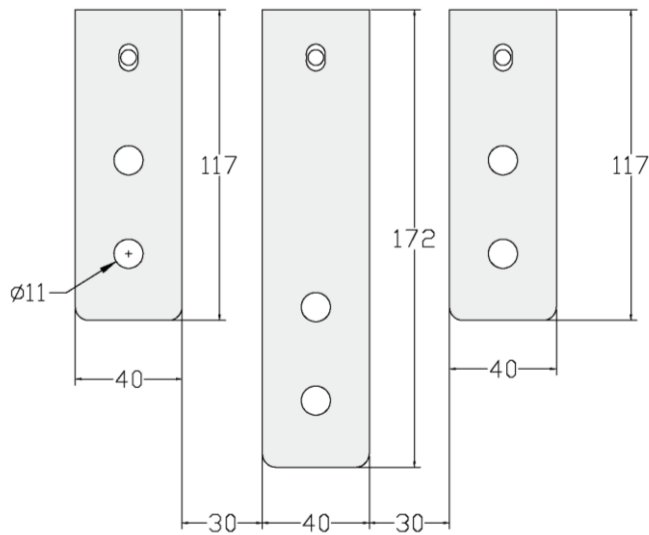

Fig. 6-11 PWS1-50K to 150K series with STS module AC wiring copper bars dimension for Grid

Open the dam-board of back door and then can see the wiring copper bar as shown below.

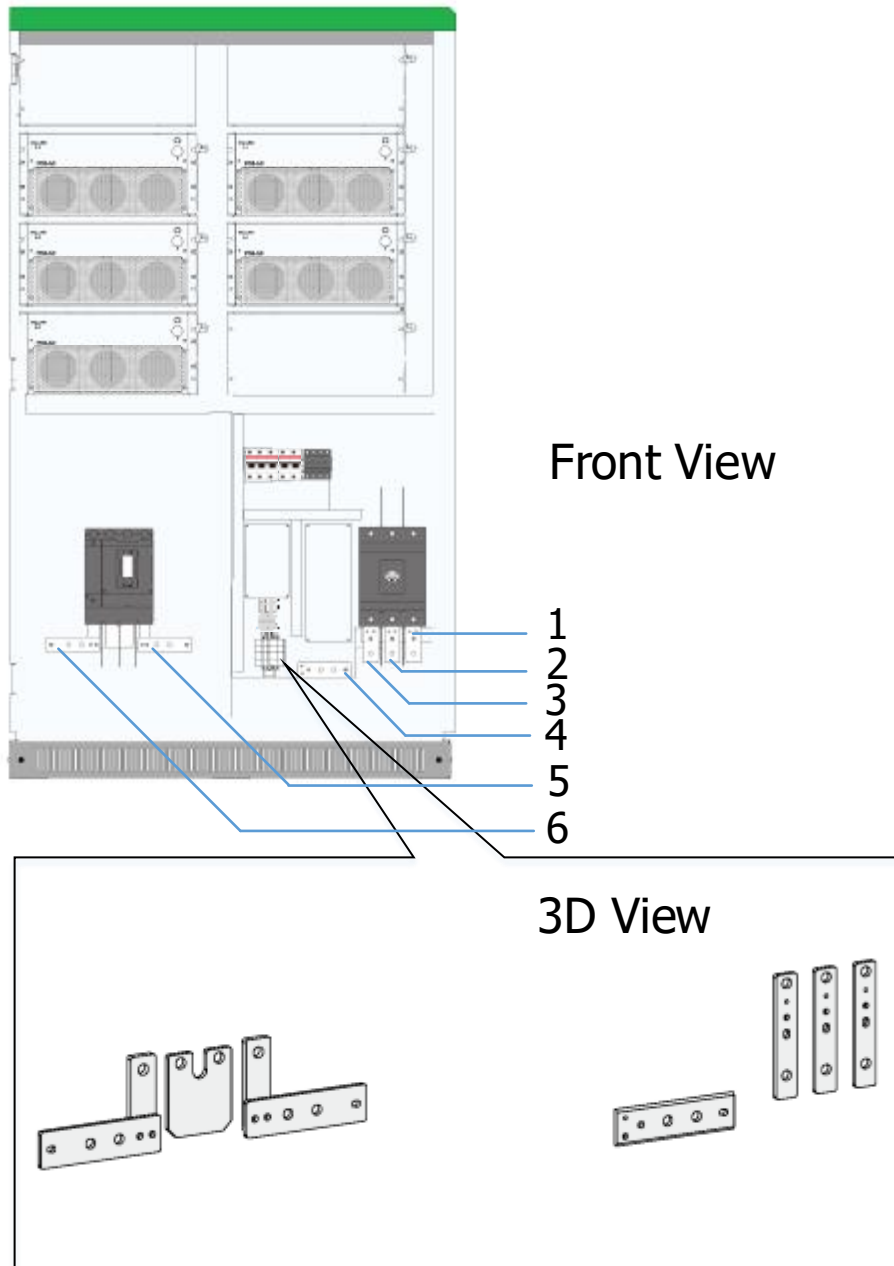

Fig. 6-12 PWS1-250K series with 1 branch DC input cabinet wiring copper bars designation

Table 6-3 PWS1-250K series with 8 branch DC input cabinet wiring copper bars description

Position	Designation	Description
1	C	Phase C, dimension is shown as below.
2	B	Phase B
3	A	Phase A
4	N	Phase N
5	Battery -	Battery negative port
6	Battery +	Battery positive port

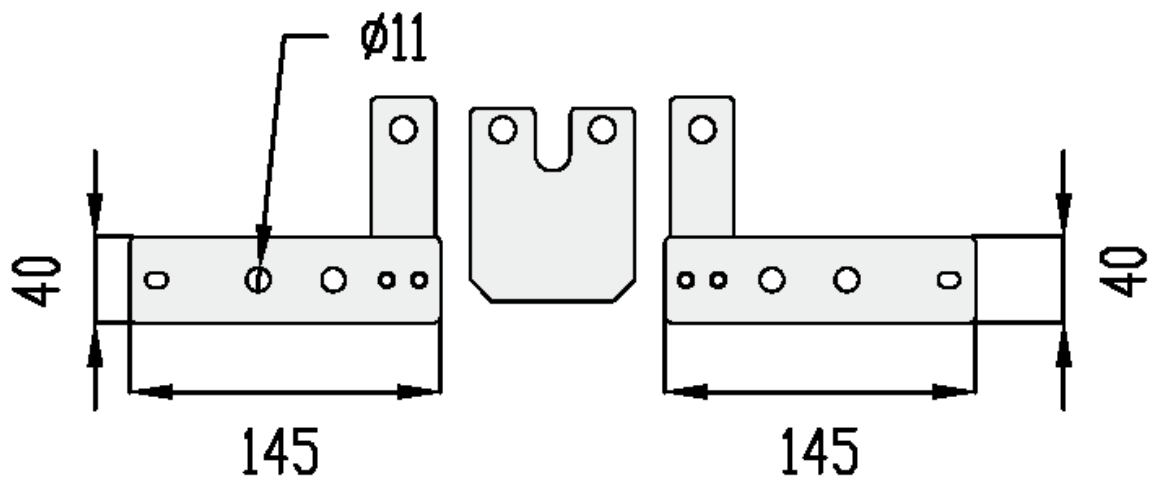

Fig. 6-13 PWS1-250K series DC input DC wiring copper bar dimension

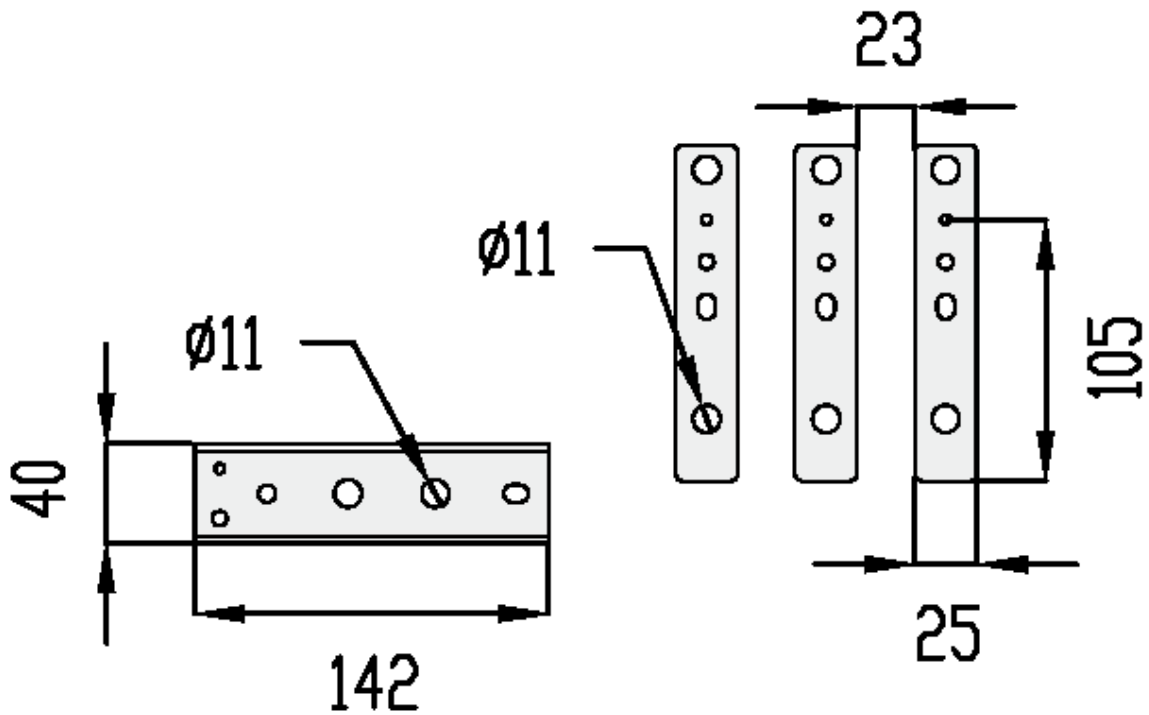

Fig. 6-14 PWS1-250K series AC wiring copper bars dimension

6.3.4 System grounding

The modules in the PCS realize grounding connection with the rack through hangers. As for rack grounding, the rack bottom is installed with grounded copper bars. During wiring, refer to the following table for cable diameter. The grounding resistance should be less than 4Ω .



WARNING

Notice that the AC output neutral is not bonded to ground.

Table 6-5 Grounding PE cable description

Rated power	Copper PE line section recommendation (mm ²)
50kW	≥16
100kW	≥25
150kW	≥35
250kW	≥45



WARNING

Rack and modules need to be grounded reliably! The grounding resistance should be less than 4Ω.

6.3.5 DC port wiring

The DC port wiring should be done before power on, the detailed DC port wiring could be seen in installation manual.



DANGER

Disconnect DC distribution switch and ensure that there is no dangerous voltage in the system during wiring.



NOTICE

The positive and negative poles of batteries cannot be connected inversely. Before wiring, a multi-meter needs to be used for measurement.

6.3.6 AC port wiring

The AC port wiring should be done before power on, the detailed DC port wiring could be seen in installation manual.



WARNING

Ensure that there is no dangerous voltage at connection points during wiring.



NOTICE

All wires are connected to the wiring terminals externally from the wiring holes at the bottom of PCS. After wiring, fireproofing mud should be used to seal the wiring holes.

6.3.7 Wiring of terminal strips

Except power cable connection in the whole PCS, there are also auxiliary power connection, input and output of some node signals. All of them are led to the terminal strips with cluster cables in the rack. The port definition of external wiring for terminal strips is shown in figure below.

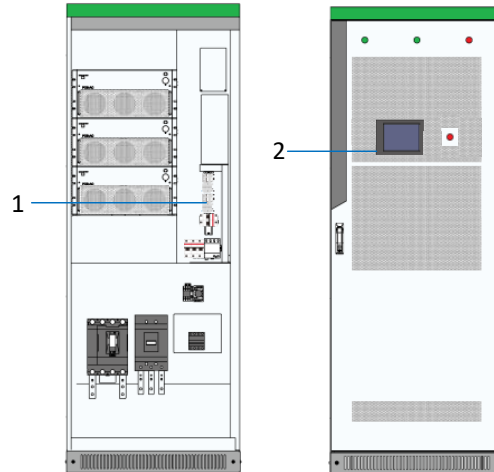

Fig. 6-15 PWS1-50K to 150K series wiring and communication interface position

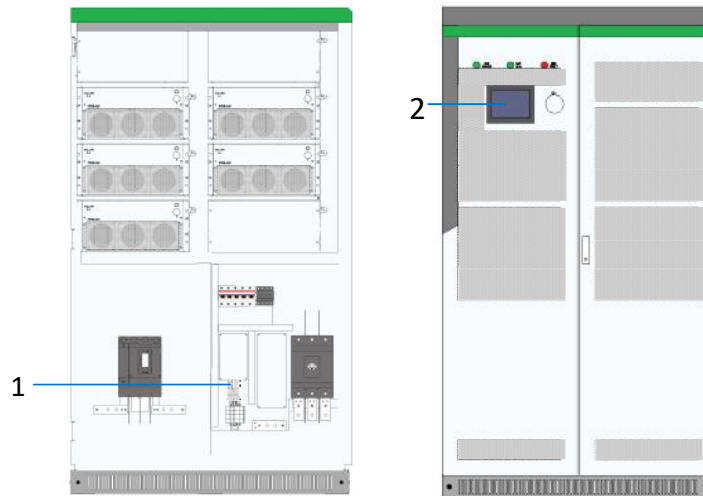

Fig. 6-16 PWS1-250K series wiring and communication interface position

Table 6-6 Communication interface description

Interface position	Description	Explanation
1	Terminal strip ports	RS485 , CAN, DI, DO, AUX power Shown as 6.3.7 Wiring of terminal strips
2	Touch Screen	Ethernet port Shown as 6.4 Communication interface

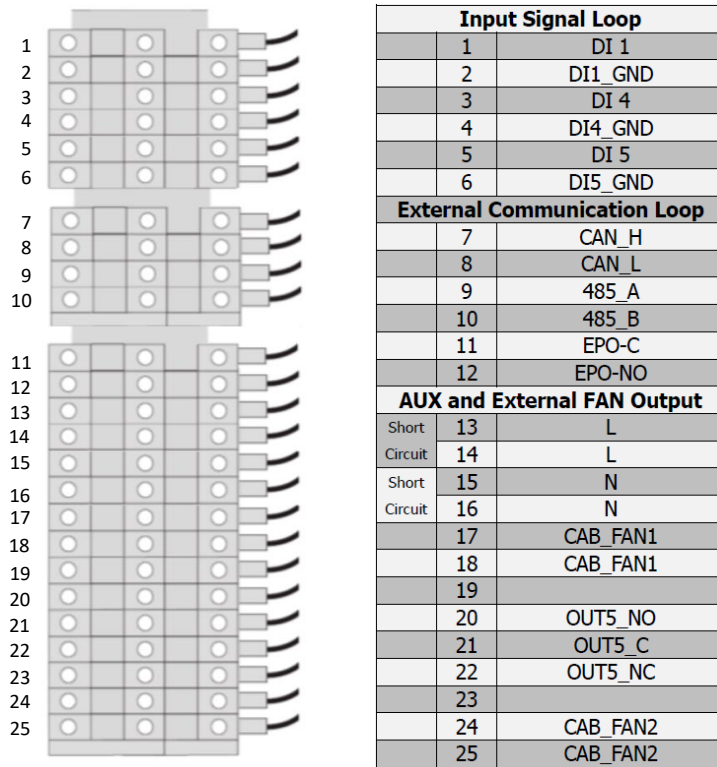

Fig. 6-17 Definition of terminal strip ports for PWS1-50K to 150K and PWS1-250K with 1 DC branch

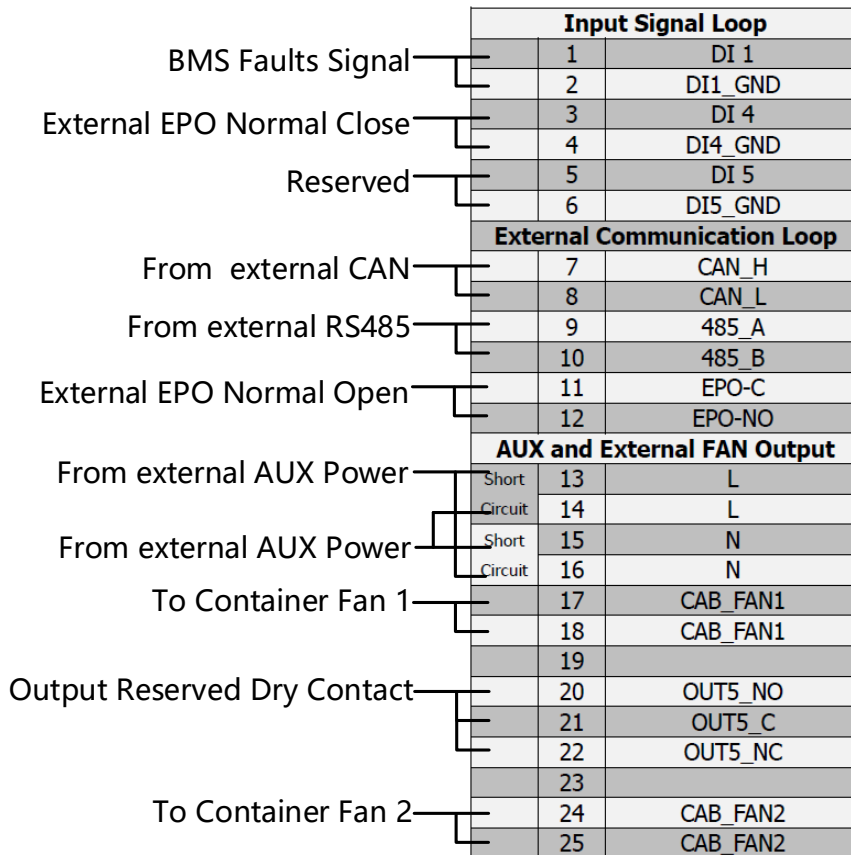

Fig. 6-18 Definition of terminal strip ports for PWS1-50K to 150K and PWS1-250K with 1 DC branch

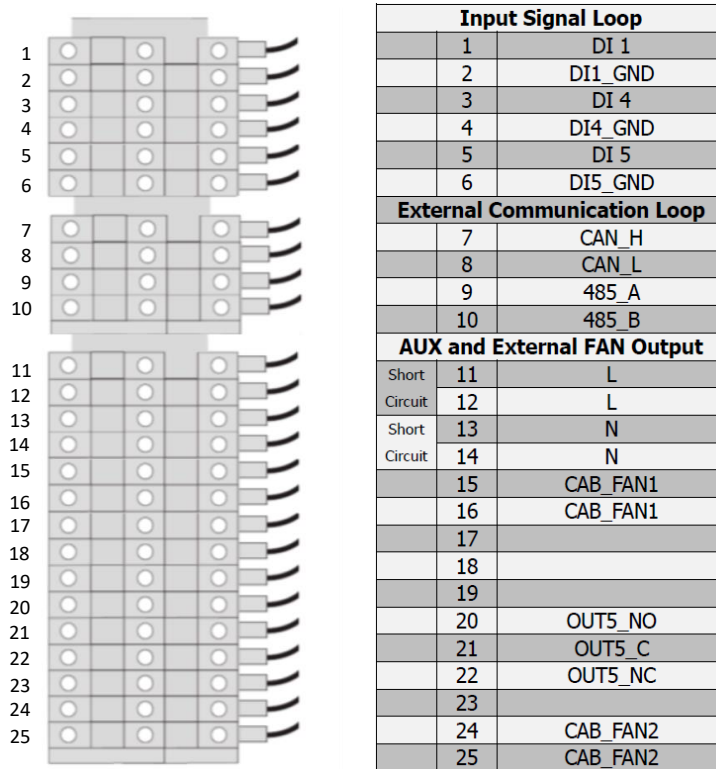
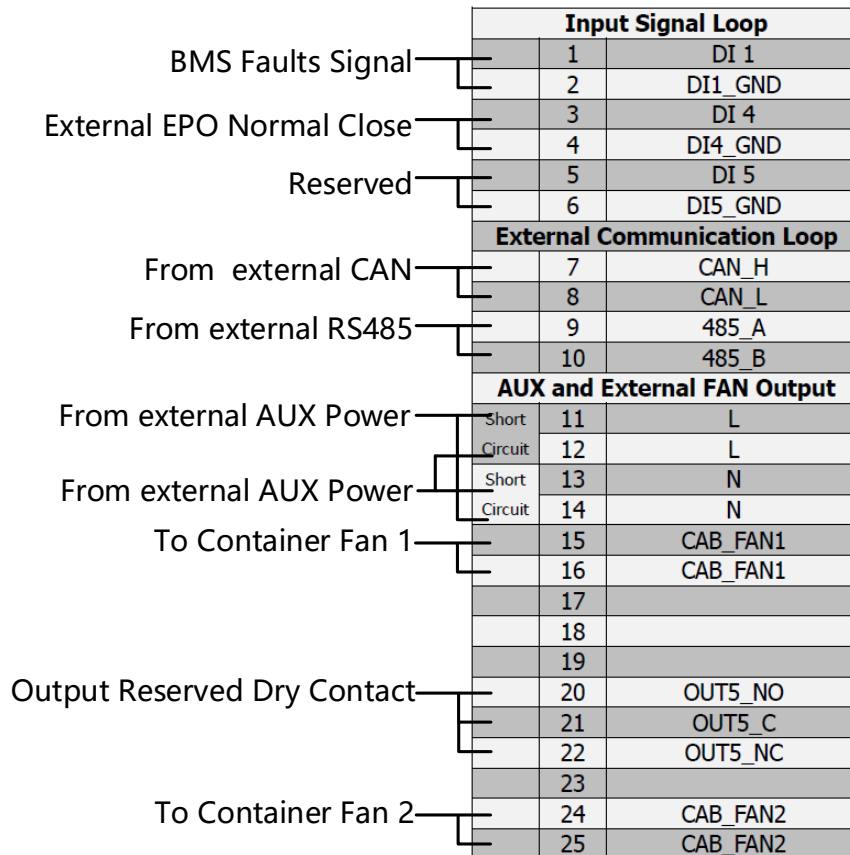

Fig. 6-19 Definition of terminal strip ports for PWS1-250K with 4 DC branch



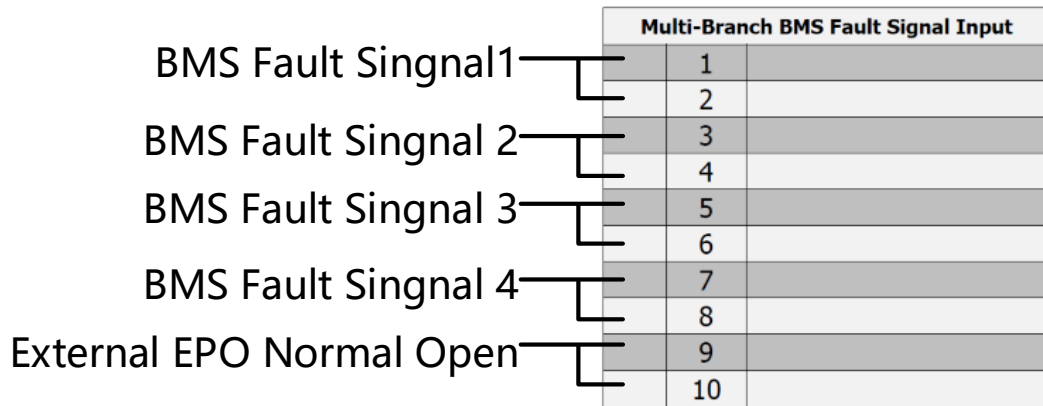

Fig. 6-20 Definition of terminal strip ports for PWS1-250K with 4 DC branch

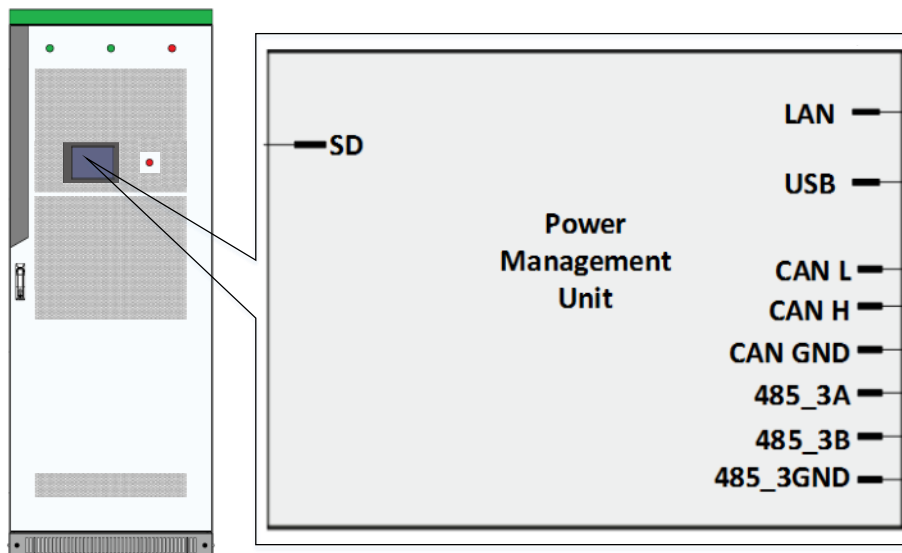

Fig. 6-21 Definition of PWS1-50K to 150K series touch screen communication ports

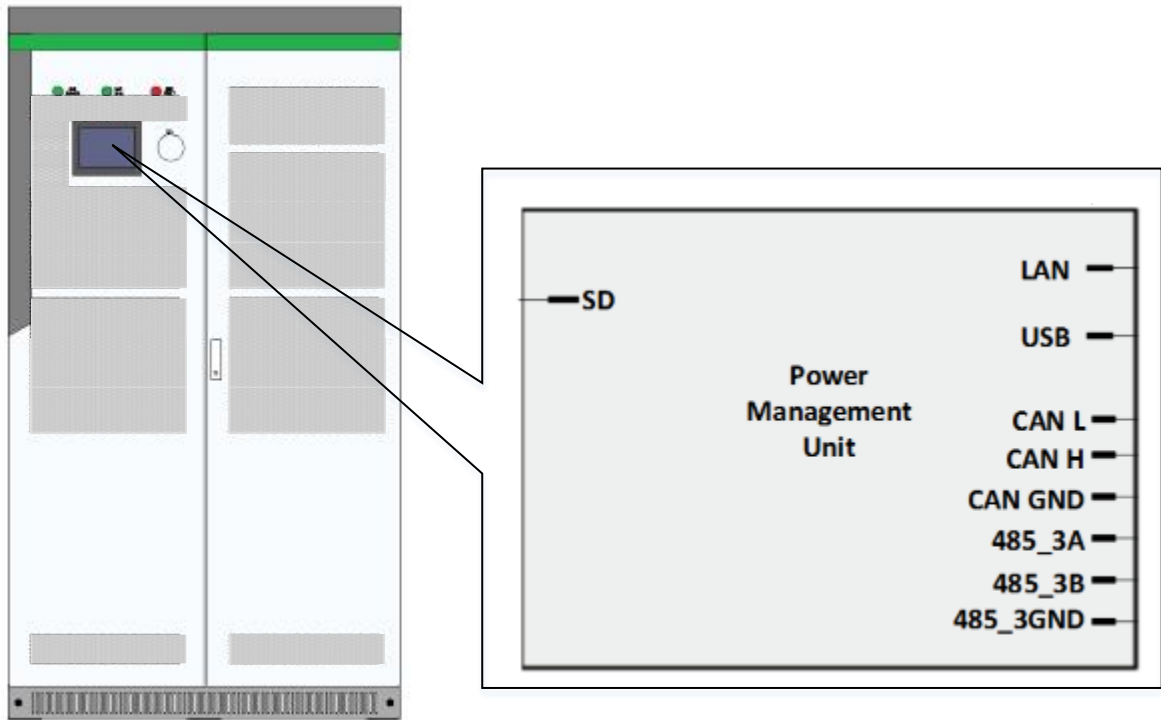

Fig. 6-22 Definition of PWS1-250K series touch screen communication ports

The LAN (Ethernet) port is used for communication. The USB port is used for system update or the logs export. The other communication ports in the back of touch screen has been wired to the wiring terminal strip ports.

6.4 Communication interface connection

The PCS supports Modbus protocol, adopts RS485 and Ethernet communication interface and facilitates users to conduct background monitoring for the PCS and realizes remote signaling, remote metering, remote control and remote regulating of storage inverter.

Table 6-7 Communication interface with other equipment

Equipment	Wiring Method
EMS	RS485 or Ethernet (Protocol is based on MODBUS TCP/IP or MODBUS RTU compatible with SUNSPEC/MESA) Defaulted as RS485 MODEBUS RTU. Use Ethernet when the system require fast control. When the EMS need to communicate in CAN method, a CAN to Ethernet communication protocol converter is required.
BMS	RS485 or Ethernet or CAN (Protocol is based on MODBUS TCP/IP or MODBUS RTU compatible with SUNSPEC/MESA) Defaulted as CAN When the BMS need to communicate in Ethernet method, an Ethernet to CAN communication protocol converter is required.
Another PCS	CAN
Smart meter	Through external EMS
Air Conditioning	Through external EMS
Fire Fighting System	Through external EMS
Water Level Gauge	Through external EMS
Diesel Generators	Through external EMS

6.4.1 Connecting the EMS over RS485 or Ethernet

Sinexcel's PCS has several different communication interfaces: Ethernet, RS-485 and CAN.

When connecting to the Sinexcel or other brand EMS, the communication port is default as RS 485 as shown below.

The Ethernet communication port can also be used to connect EMS according to the requirements for certain projects.

RS 485 Port

The front door of the storage inverter is embedded with touch screen Management Unit. User interface can be seen at its back. The position number of RS485 communication interface in the HMI (Touch Screen) is J23. It is led to terminal strip ports 9 and 10. Users can transfer serial port signal to the one which can be processed by PC via interface converter (such as RS485 transferred to RS232). The storage inverter could be set and commissioned alone via background software. It can read operation and warning information. Corresponding settings, startup and shut down operations can be conducted.

Ethernet Port

The monitoring panel integrates Ethernet port with position numbered as RJ25 that can be seen in the back of the touch screen. It supports Modbus TCP/IP protocol and has its own IP address. Ethernet connection requires a switch router, and fixed IP needs to be set. Connecting cables are twisted pair (namely network cable). The storage inverter are connected to the switch router, and the switch router is connected to remote control computer. The state of the storage inverter can be monitored and controlled in real time after setting IP address and port number in the monitoring computer.

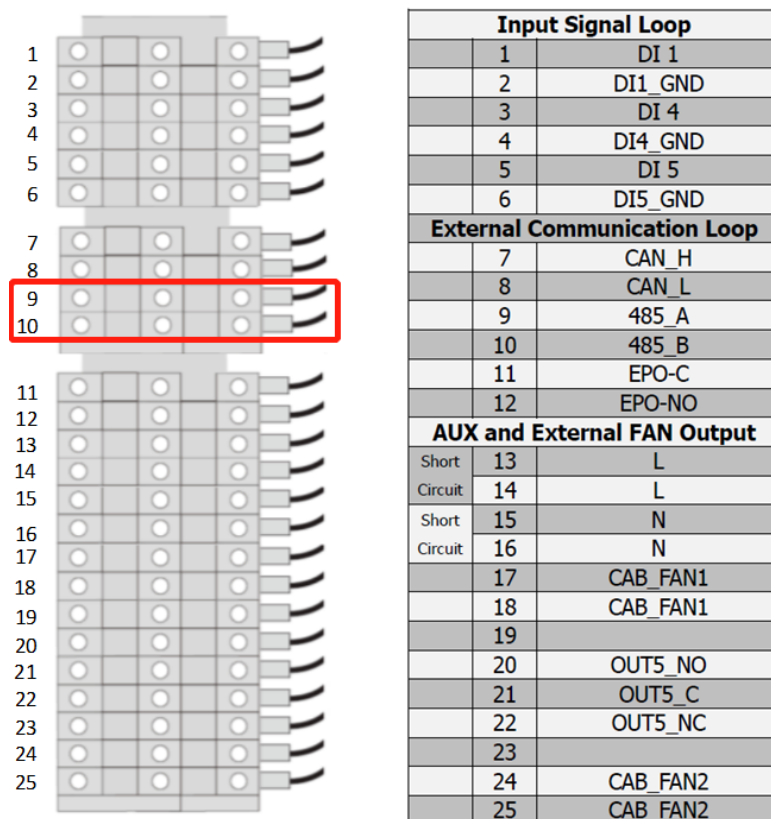

Fig. 6-23 PCS RS485 communication terminal

6.4.2 Connecting a BMS over CAN

When directly connecting to the BMS, the communication port is default as CAN as shown below. If the BMS use Ethernet communication port, a Ethernet-CAN protocol converter is needed . That Ethernet-CAN protocol converter should be bought by the user and its beyond Sinexcel's scope of supply. The PCS communicates with battery management unit (BMS) to monitor battery state information, give an alarm and provide fault protection for battery according to the battery state and improve the safety of storage battery. It supports CAN communication. In particular, the position number of CAN communication interface can be seen in the back of HMI (Touch screen). It is led to terminal strip ports 7 and 8.

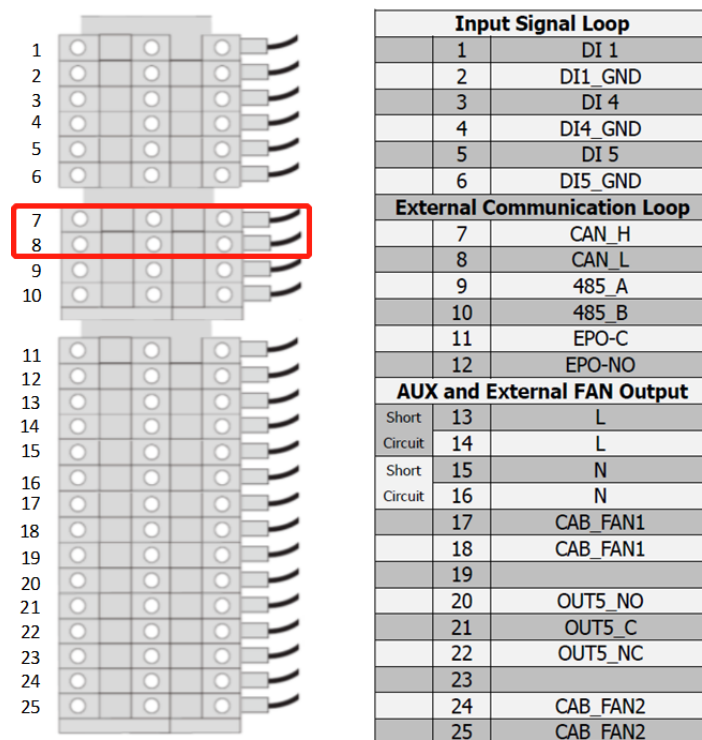

Fig. 6-24 PCS CAN communication terminal

6.5 Check after installation

After installation of PCS, please inspect all aspects according to the checklist in the Installation Manual. Any failure to complete the checklist might void the warranty.

7 Function Description

7.1 Operating Status

7.1.1 Overview of the Operating Status

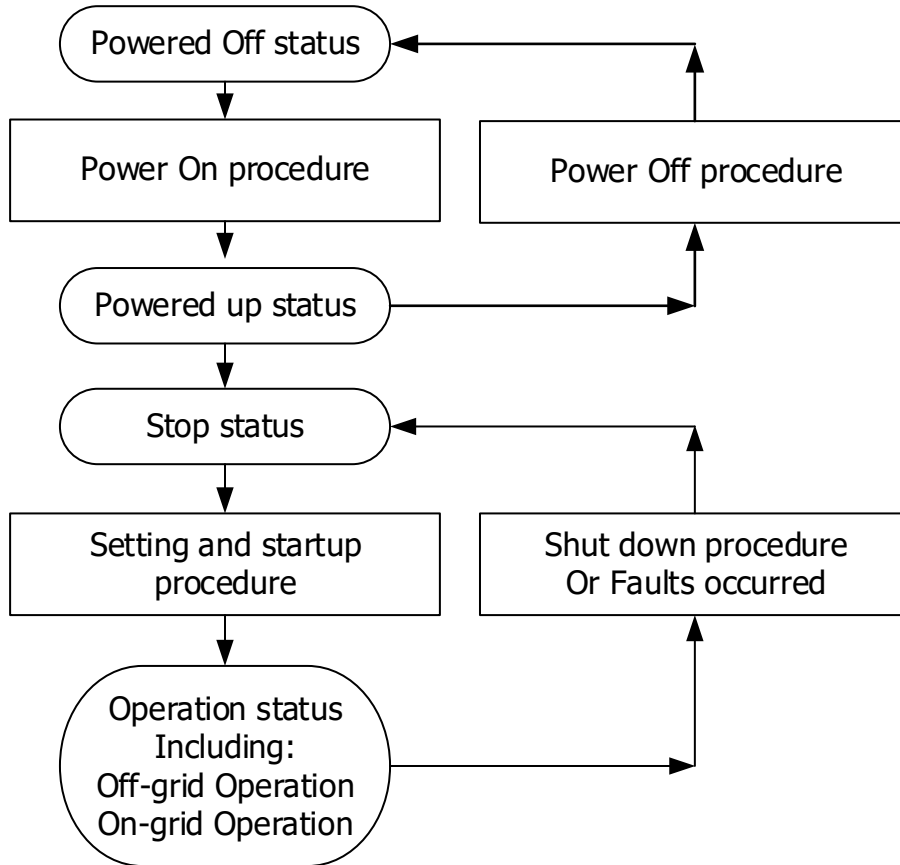

Fig. 7-1 Overall Status

Refer to the following table for status of storage inverter.

Table 7-1 Status of storage inverter

Status	Conditions	State indication
Powered off		DC and AC breaker all disconnected
Powered up		DC and AC breaker all connected
Stop	DC switch is closed, AC switch is closed, and the device might have faults occurred.	RUN green light in front door flickers quickly, and the module green light flickers quickly.
Operation	Including Off-grid and On-grid operation	
On-grid	The device does not alarm, on-grid mode is set, and the device receives startup command.	RUN green light in front door is always on, and the module green light is always on.
Off-grid	The device does not alarm, off-grid mode is set, and the device receives startup command.	RUN green light in front door is always on, and the module green light is always on.
Faults	Any fault information	Red light is always on, the module red light is always on or flickers, and the buzzer makes an alarm.
Shutdown	The device receives shutdown command.	RUN green light flickers slowly, and the module green light flickers slowly.

7.1.2 Operating States without STS

After external wiring of the storage inverter is completed, and wiring is fully checked, close the breaker in AC port. The storage inverter can be switched in different modes under the conditions below.

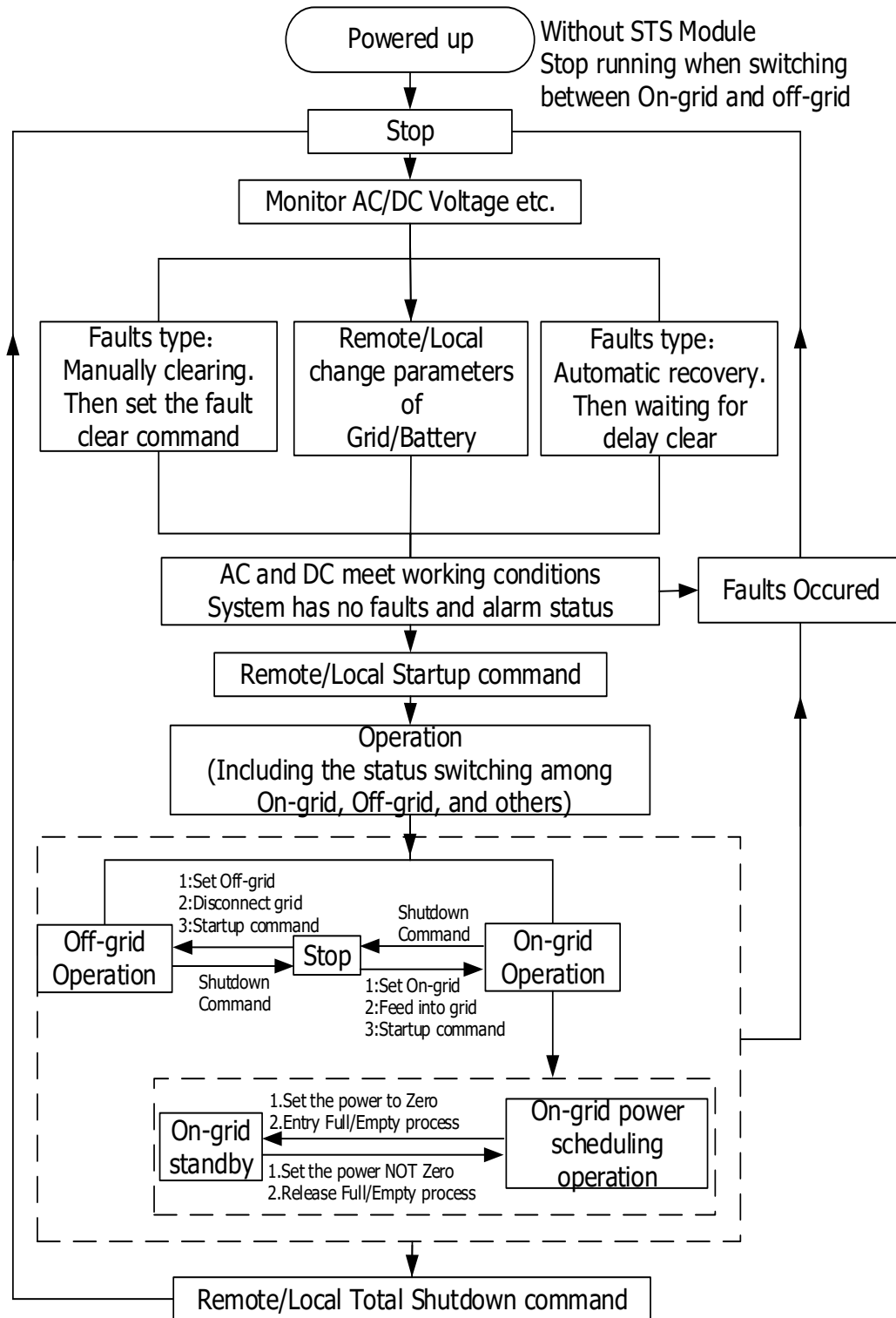

Fig. 7-2 Status diagram for storage inverter without STS module

7.1.3 Operating States with STS

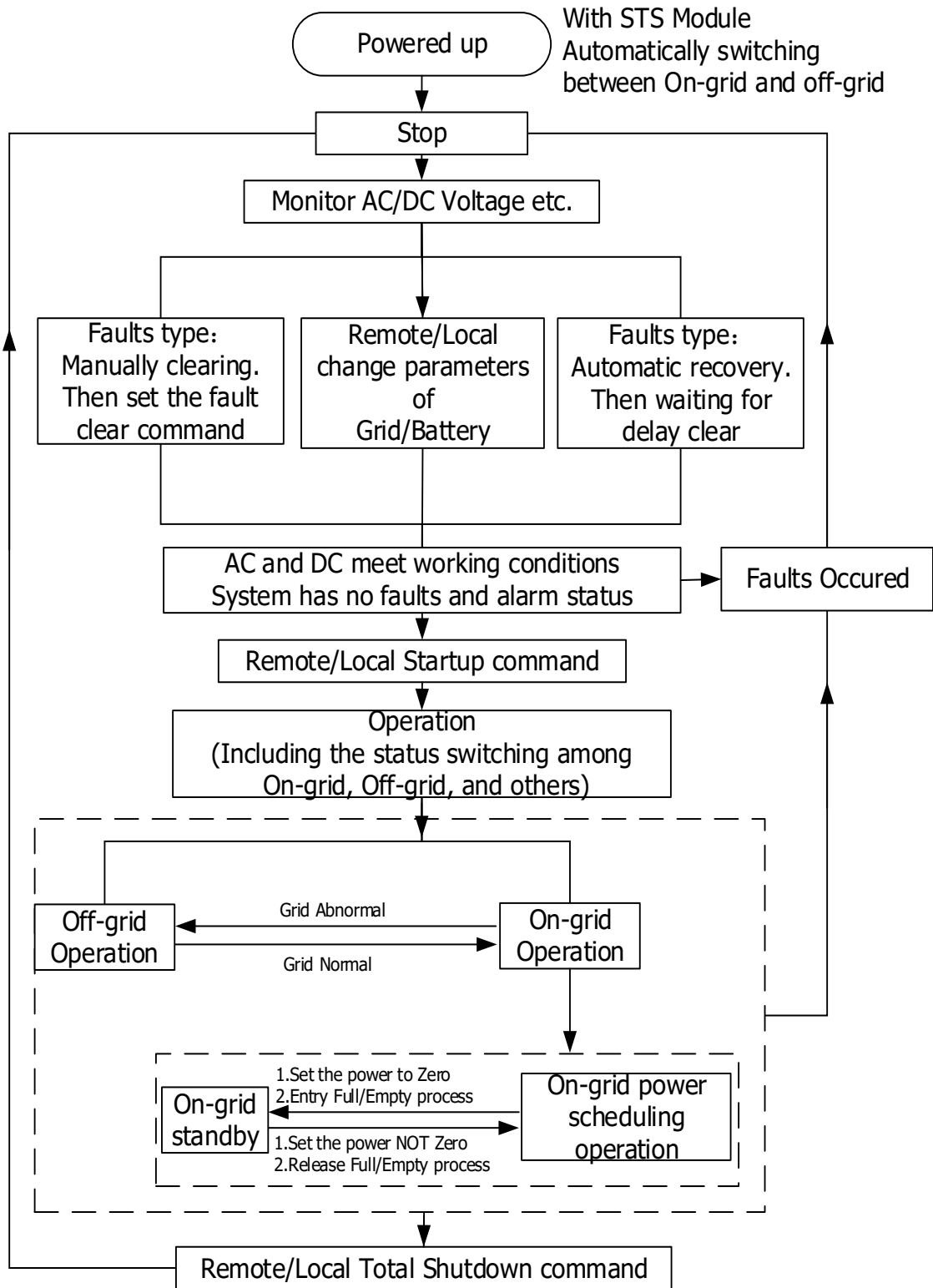

Fig. 7-3 Status diagram for storage inverter with STS module

8 Operation

8.1 Safety during Operation



NOTICE

DC side operation is disturbed due to incorrect parameter settings

When setting the mode of the AC side, please make sure that the control parameter is consistent with the grid requirement.

8.2 Power On Procedure

Power on for the first time:

- 1): Confirm the DC and AC cable firmly connected according to the check list in the Installation Manual.
- 2): Measure the insulation withstand voltage according to the international or local standard. The following insulation withstand voltage should be measured
Positive pole "+" to ground "GND"; Negative pole "-" to ground "GND".
- 3): Measure the grid AC voltage; Battery DC voltage;
- 4): If the grid AC voltage; Battery DC voltage within the normal range as shown in technical specifications, then close the switch in sequence.

Power on every time:

- 1): Check whether the EPO button in reset state.
- 2): Close the switch in sequence.

Firstly close the AC switch, after the AC switch all closed then close the DC switch.

The switch operation sequence is shown as below:

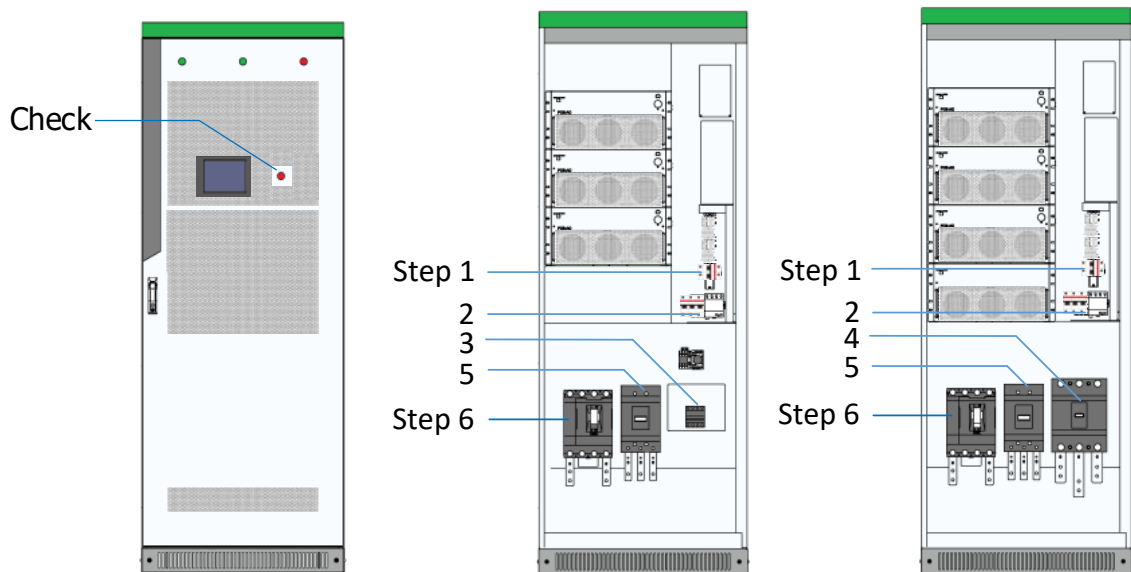

Fig. 8-1 PWS1-50K to 150K series Power on sequence without STS module

with STS module

Fig. 8-2 PWS1-50K to 150K series power on sequence for the model without STS:

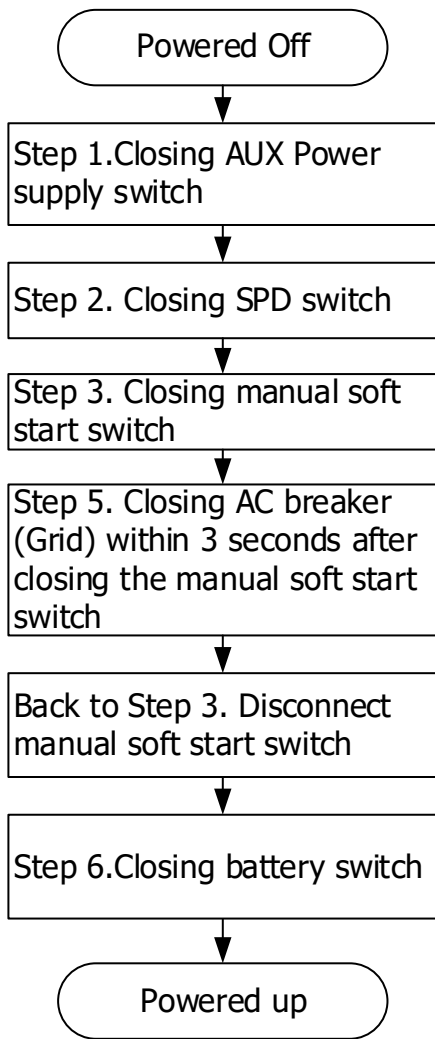

Fig. 8-3 PWS1-50K to 150K series power on sequence for the model with STS:

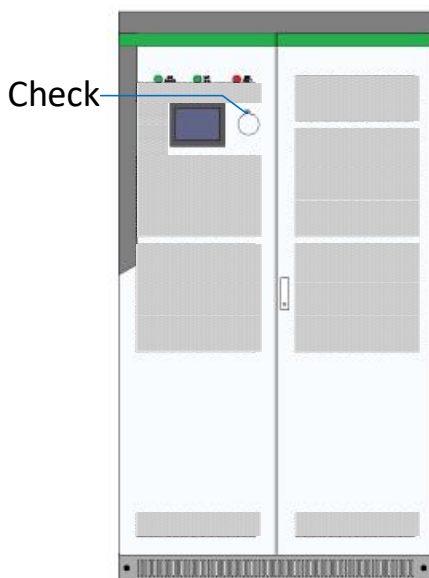
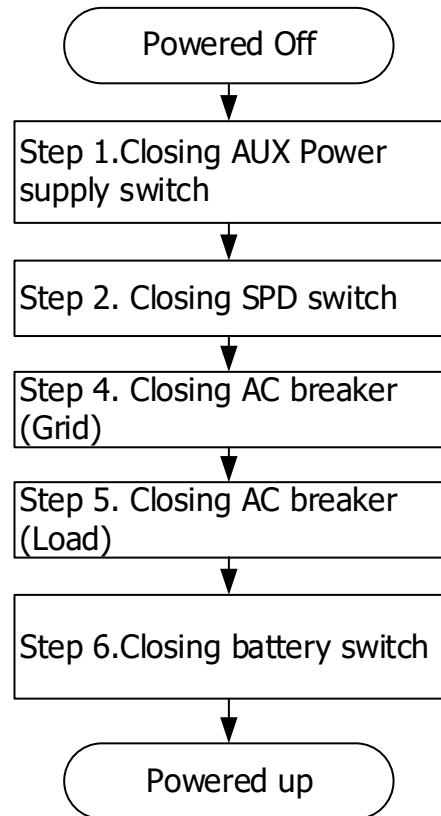
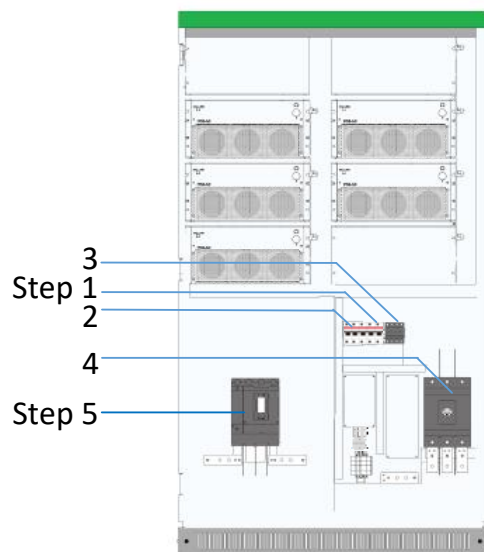

Fig. 8-4 Power on sequence

8 Branch DC Input



1 Branch DC Input

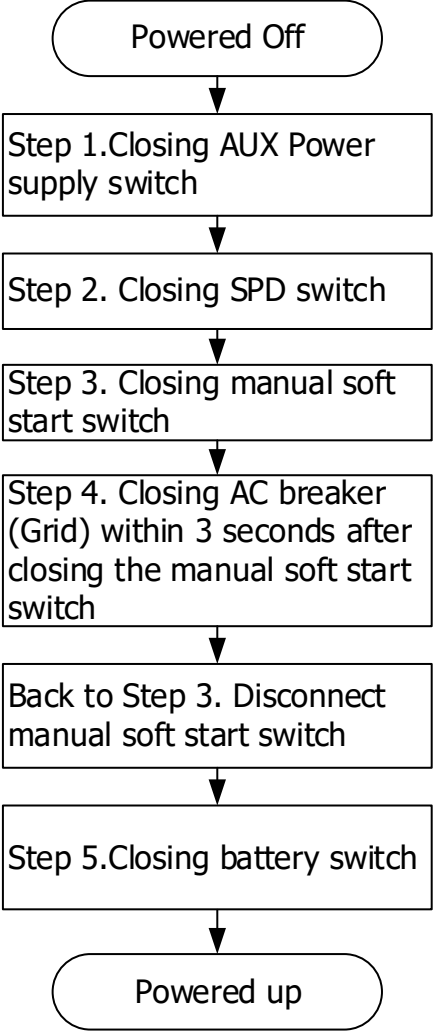

Fig. 8-5 Power on sequence for the PWS1-250K series PCS.

8.3 Setting Procedure before startup

8.3.1 Touch screen power on

After auxiliary power of the storage inverter is connected, THE HMI is on. At this moment, an initializing interface will appear. It shows that **"The system is booting, please wait**". After system booting, the interface will disappear.

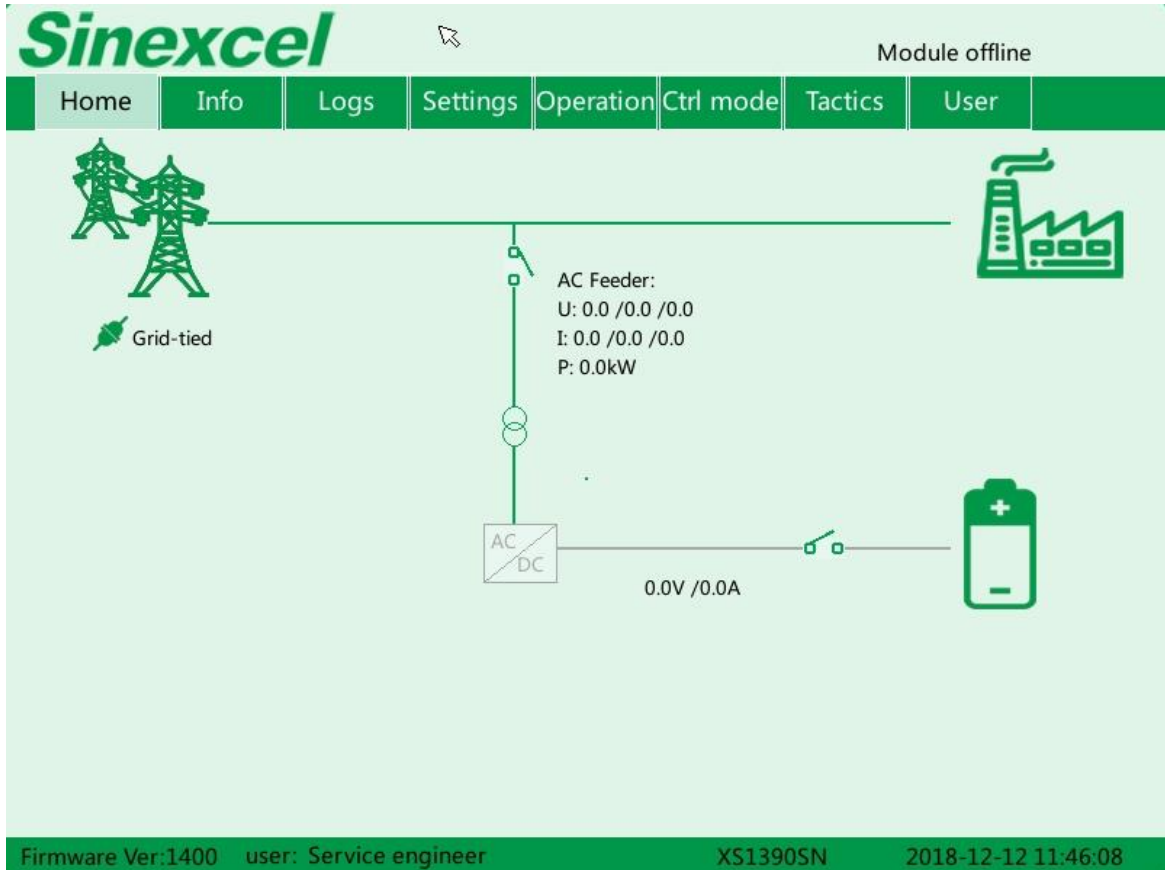

Fig. 8-4 Main Interface Sample

Detailed Menu information can be seen in Appendix. "11.1 Touch Screen Startup"

8.3.2 Log into the control Interface

1. Select **"User"**, Log into the control interface on touch screen with password.
2. User can get the password from the authorized person/ party / agency/ etc.

The login password 123456789 can obtain administrator authority.

8.3.3 Select Control Mode

Main menu structure can be different in different **"Ctrl Mode"**.

Configuring the control mode

1. Select **"User"**, Log into the control interface on touch screen with password.
2. Select **"Ctrl Mode"** > **"Manual Operate"**

Then the **"Settings"** is visible.

8.3.4 General Settings

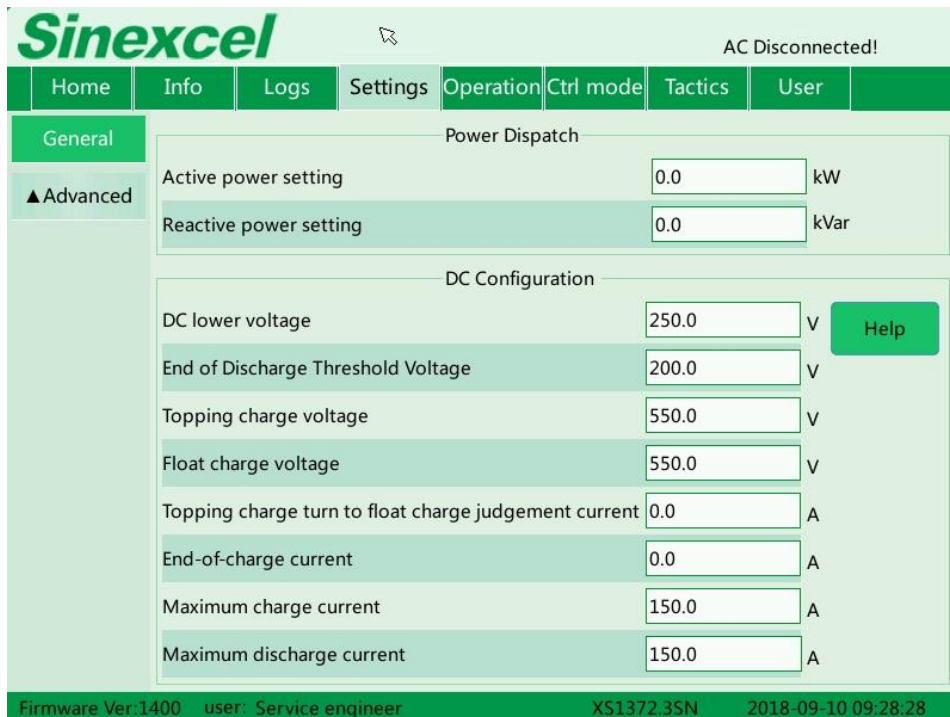

Fig. 8-5 Setting Interface Sample

There are General Setting and Advanced Setting, the commonly used setting is in the **“General”** Users should set the **“DC Configuration”** according to the voltage and current requirement of BMS. The detailed advanced setting can be seen in **Appendix1 12.4 Parameter Setting**.

8.3.5 Communication setting

Procedure:

1. Select **“User”**> Input password> **“OK”**>**“Login”**. (Log into the PCS user interface)
2. Select **“Ctrl mode”**> **“Manual Operate”**.
3. Select **“Setting”**> **“Advanced”**>**“HMI”**>**“IP”** to set the IP of PCS. Enter the static IP address that you want to use to access the PCS.
4. Then click **“OK”** to save or click **“ESC”** to discard changes.
5. To change the gateway IP address of your network, enter the IP address in **“Gateway”**.
6. To change the subnet mask of your network in the field Subnet mask, enter the **“Subnet mask”**.
7. To change the Modbus address of your PCS, enter the **“Modbus address”**.
8. To change the baud rate of MODBUS communication, enter the **“RTU baud rate”**.

8.4 Manual Startup Procedure

Check before startup

1. Select **“User”**, Log into the control interface on touch screen with password.
2. Select **“Ctrl Mode”** > **“Manual Operate”**
3. Select **“Operation”**, the detailed menu explanation can be seen in Appendix.
4. Select **“Operation”** >**“System Startup”**

The detailed menu explanation can be seen in **Appendix1 12.7 Manual Startup**.

8.5 Automatic Startup Procedure

1. Select **"User"**, Log into the control interface on touch screen with password.
2. Select **"Ctrl Mode"** > **"Automatic Operate"**

The detailed menu explanation can be seen in **Appendix1 12.8 Automatic startup.**

8.6 Remote Startup Procedure

1. Select **"User"**, Log into the control interface on touch screen with password.
2. Select **"Ctrl Mode"** > **"Remote Control"**
3. Then with other control equipment to start the PCS remotely.

The detailed menu explanation can be seen in **Appendix1 12.9 Remote startup.**

8.7 Shutdown Procedure

During normal operation of storage inverter, the following steps can be conducted if shutdown is required.

Remote shutdown procedure

1. The PCS is working in remote control mode and then with other control equipment to stop the PCS remotely.

Manual shutdown procedure

1. **"Ctrl Mode"** > **"Manual Operate"**;
2. **Select "Operation"** > **"System Stop"** to manually stop the PCS.

The detailed menu explanation can be seen in **Appendix1 12.10 Shutdown procedure.**

8.8 System Power Off

When PCS is in "Stop" mode, can cut off the DC and AC power and power off the system

- 1): Manually or remote control the system stop.
- 2): Disconnect the AC switch.
- 3): Disconnect the Battery DC switch.

The detailed menu explanation can be seen in **Appendix1 12.11 System Power Off**

8.9 Emergency shutdown

When the storage inverter system is abnormal, press the emergency shutdown button "EPO" on the rack door and the PCS will instantly stop running.



To prevent personal injury, please use a multi-meter to measure the voltage at input terminal if case maintenance or opening is conducted. After ensuring that there is no mains supply, relevant operation can be conducted!

After about 15 minutes, the upper cover plate can be opened after DC BUS bar capacitance fully discharges (refer to warning label on module case surface).

9 Troubleshooting

9.1 Safety during Troubleshooting



DANGER

Danger of electric shock due to high voltage on the product

There may be high voltages on the product under fault conditions. Touching real-time components can lead to danger or death

Serious injury due to electric shock.

Observe all safety information when operating the product.

Wear appropriate personal protective equipment for all work on the product.

If you are unable to resolve the interference with this document, please contact the manufacture.

9.2 Export fault record

Insert a USB flash disk into the USB port in the back of the touch screen.

When need to send the logs to the manufacture to analyze.

1. Select "**User**", Log into the control interface on touch screen with password.
2. Select "**Ctrl Mode**" > "**Manual Operate**"
3. Select "**logs**" > "**Export Logs**">"**Download All Logs**"

9.3 Faults caused by improper parameter settings

Table below shows the faults that caused by improper parameter setting.

User could reset the parameter under the instruction in Appendix and then the faults can be automatically solved.



NOTICE

Alarm classification:

Fault: shutdown.

Warning: alarm but not shut down;

Alarm Clearance method:

Auto: After the cause of the alarm disappears, the alarm is automatically cleared.

Manual: After the cause of the alarm disappears, you need to manually send an alarm clear command.

Power Off: After the causes of the alarm disappear, you need to power off and restart.

Alarm Classification + Clearance Method (**abbreviate to A.C. + C.M.:**)

Fault + Auto

Fault + Manual

Fault + Power Off

Warning + Auto

Warning + Power Off

Failure Name	A.C.+C.M.	Reason
AC bus over voltage	Fault + Auto	PCS AC bus voltage is higher than the overvoltage protection setting
AC bus under voltage	Fault + Auto	PCS AC bus voltage is lower than the under voltage protection setting
AC bus over frequency	Fault + Auto	PCS AC bus frequency is higher than over frequency protection setting
AC bus under frequency	Fault + Auto	PCS AC bus frequency is lower than the under frequency protection setting
Grid over voltage	Fault + Auto	Only for the models with STS, the grid voltage is higher than the overvoltage protection setting
Grid under voltage	Fault + Auto	Only for the models with STS, the grid voltage is higher than the overvoltage protection setting
Grid over frequency	Fault + Auto	Only for the models with STS, the grid frequency is higher than the over frequency protection setting
Grid under frequency	Fault + Auto	Only for the models with STS, the grid frequency is lower than the under frequency protection setting
DC input over voltage	Fault + Auto	PCS DC voltage is higher than the upper voltage limit
DC input under voltage	Fault + Auto	PCS DC voltage is lower than the lower voltage limit or DC voltage is not connected
DC bus over voltage	Fault + Auto	The voltage on the DC bus capacitor is too high during module working
DC bus under voltage	Fault + Auto	The voltage on the DC bus capacitor is too low during module operation
Battery under energy	Fault + Auto	1. The BMS is emptied when in off-grid state; 2. The DC voltage is lower than the discharge termination voltage of <DC parameter> in the off-grid state;
Parameter mismatch	Fault + Auto	1. The parameter setting of <DC parameter> is unreasonable; 2. When the system is running in the off-grid condition, the number of AC modules running is more than the number of DC modules running.

Table 9-1 Faults caused by improper parameter setting

9.4 Detailed Troubleshooting

The detailed troubleshooting can be got from the manufacture or retailer.

10 Maintenance

10.1 Safety during Maintenance



DANGER

There is a high voltage in the live components of the product. Touching field components can result in death or seriousness electric shock damage.

Wear appropriate personal protective equipment for all work on the product.

Do not touch any live components.

Observe all warning messages in products and documents.

Obey all safety information from the battery manufacturer.

Always disconnect the following devices from the outside before performing any work:

- grid voltage fed by the grid
- internal power supply
- DC voltage of the battery
- additional external voltage, such as control signal from the control room

Make sure that the disconnected device cannot be reconnected.

After turning off the inverter, wait at least 15 minutes before turning it on to discharge the capacitor complete.

Before operating the drive, make sure that all devices are completely voltage free.

Cover or isolate any adjacent live components.



NOTICE

Property damage due to dust intrusion and moisture infiltration

Ingress of dust or moisture can damage the product and affect its function.

Perform maintenance work only when the environment is dry and free of dust.

The product is only allowed to wiring or assembly and disassembly operate when the product is turned off.

Connect the external power supply after finish installing the product.

If the installation or commissioning process is interrupted, install all dam panels, close and lock the rack.

The product must always be closed for storage.

Store the product in a dry, covered area.

10.2 Maintenance Schedule and Consumables

10.2.1 Operation environment requirements

Device operation environment must comply with the operation environment required for the device:

Allowable environment temperature: -20~55°C (power de-rating for 45 °C above)

Allowable relative humidity: 0~95% (non-condensing)

Allowable maximum elevation: 3,000m

Note: When exceeding the maximum elevation, the PCS will have de-rating output.

Please consult customer service center for specific de-rating coefficient.

10.2.2 Electrical and fixed connection inspection

After being put into operation, conduct regular inspection on device's electrical and fixed part connection. Such inspection is advisably conducted every three months. Record for each inspection should be made.

- Rack grounding connection;
- Module grounding connection;
- Electrical connection for DC input;
- Electrical connection for AC input;
- Electrical connection for auxiliary power supply;
- Electrical connection for communication cables.
- AC/DC switch, SPD and fan.
- Access monitored fault information.

10.2.3 Clearing and cleaning

Before the device is put into operation, the dust and sundries in its cooper bars, terminals and mesh openings should be cleaned.

After the device is put into operation, the dust in machine room should be cleaned regularly. Check whether the ventilating and air exhaust facilities in machine room are normal. They are advisably cleaned once every three months.

10.3 Maintenance Work

Unfavorable environmental conditions shorten maintenance intervals

Location and environmental conditions can affect maintenance intervals. Pay attention to cleaning and corrosion protection

It may need to be more frequent, depending on the conditions at the installation site.

If the DC power distribution parts is affected by adverse environmental conditions, it is recommended to shorten maintenance interval.

Sinexcel recommends an optical inspection in regular periods to determine maintenance requirements

Consumables and maintenance materials

Only those consumables and maintenance materials are usually not included in standard equipment list.

Professionals or electrically qualified person listed standard tools and materials such as torque are taken for granted.

Wrench, single contact voltage tester are available for all maintenance operations.

Maintenance work under the voltage supply.

See the information in HMI

Read error messages and warnings

Check DC Switchgear

Check the AC disconnect device

Check the fan

Maintenance under no voltage conditions

See the information in HMI

Performing a visual inspection

Cleaning the ventilation panels

Cleaning air ducts and ventilation ducts

Check internal

Check the bolt connection of the power cord.

Check label

Check latches, door stops and hinges.

Check the SPD (Surge Protecting Device)

11 Contact

If you have technical problems with our products, please contact the service hotline. Please provide the following information to help you with the necessary assistance:

- Equipment model
- serial number
- Battery Type and number
- Communication type
- Firmware version
- Error number and error message

Shenzhen Sinexcel Electric Co., Ltd.

Website: <http://sinexcel.us/> or www.sinexcel.com

Add: Building 6, Area 2, Baiwangxin High-tech Industrial Park, No. 1002, Songbai Road, Nanshan District, Shenzhen

Postcode: 518055

Hotline: +86 0755-8651-1588

Appendix 1 Settings on HMI (Touch Screen)

12.1 Touch Screen Startup

Operation control can be conducted via HMI (human-computer interface). This section introduces the HMI display content and settable parameters.

The **"Home"**, **"Info"**, **"Logs"**, **"User"** can always be seen before log-in with a password. The detailed menu structure can be seen as below.

12.1.1 Main Menu Structure before log-in

All these information bellow can be visible after the system booting and touch screen can be normally display.

"Home", **"Info"**, **"Logs"**, **"User"** menu can be seen in the main menu structure before login.

12.1.1.1 Home

After initializing, the home page is shown. On the main wiring diagram of system topology, system AC/DC voltage and current, general system status can be seen.

1. Log into the PCS user interface
2. Select **"Home"**

12.1.1.2 Information

1. Log into the PCS user interface.
2. Select **"Home"** > **"Info"**

In the Info pages, users can get the overview of the entire system operation parameters.

The branch menu **"DC Info"**, **"AC Info"**, **"Grid Info"**, **"Load Info"**, **"Status"**, **"BMS"** can be seen under the menu **"Info"**

User can see the specific information under each menu

"DC Info" shown the status of DC BUS, battery is connected to the DC BUS.

"DC Voltage (V)" **"DC Current (A)"** **"DC Power (kw)"** **"Status"** **"Warning"** **"Switch"** **"Bus Voltage (V)"** can be seen under the **"DC Info"**.



NOTICE

"AC Info" shows the status of AC output. When without the STS or other on-grid/off-grid Switching device, grid information is the AC info during on-grid condition; load information is the AC info during the off-grid condition.

The **"Voltage (V)"** **"Current (A)"** **"P (kw)"** **"Q (kVar)"** **"S (KV a)"** **"PF"** information of each live line in three phase **"L1"** **"L2"** **"L3"** is illustrated in a table in the **"AC Info"**.

"Total P (kw)" **"Total Q (kVar)"** **"Total S (KV a)"** **"Frequency (Hz)"** **"Charged Energy (kWh)"** **"Discharged Energy(kWh)"** can also shown under the menu **"AC Info"**.

"Charged Energy (kWh)" **"Discharged Energy(kWh)"** is the special information related with PCS charging /discharging. These two information will not shown in the **"Grid Info"** and **"Load Info"**.



NOTICE

"Grid Info" and "Load Info" is invisible when the system without STS or other on-grid/off-grid Switching device.

When the system with the STS or other switching device, the AC info parameter is different from grid info during the process of switching from On-grid to Off-grid. And the AC info parameter is different from load info during the process of switching from Off-grid to On-grid.

The "Voltage (V)" "Current (A)" "P (kw)" "Q (kVar)" "S (KVa)" "PF" information of each live line in three phase "L1" "L2" "L3" is also illustrated in a table in the "Grid Info" and "Load Info". But the "Charged Energy (kWh)" "Discharged Energy(kWh)" is only shown in "AC Info".

"Status" shows the "Version" and "Status" of different AC module and DC module.

"BMS" information is different according to different BMS supplier brands

12.1.1.3 Logs

In logs page, users can review current alarm, past alarm, operation record, status record of the system, and operation curves.

Logs		Explanation		
Current	No.	Warning/Fault	Occurrence Time	Dismissed Time
Past Alarm	No.	Warning/Fault	Occurrence Time	Dismissed Time
Operation	No.	Designation	Time Stamp	Operation
Status Logs	No.	Designation	Time	Status
Export	Downloading Process: Downloading All Logs			Invisible before log-in

12.1.2 Log into the control Interface

1. Select "User", Log into the control interface on touch screen with password.
2. User can get the password from the authorized person/ party / agency/ etc.









The login password 123456789 can obtain administrator authority.



NOTICE

Hierarchical password function, different password have different administration authority.

12.2 Main Menu Structure after log-in

Menu Level	Explanation		
Home	/	System Topology	
Info	DC Info		
	AC Info		
	Grid Info	 NOTICE Invisible without STS or other on-grid/off-grid Switching device	
	Load Info	 NOTICE Invisible without STS or other on-grid/off-grid Switching device	
	Status		
	BMS		
Logs	Current		
	Past Alarm		
	Operation		
	Status logs		
	Export logs	 NOTICE Invisible before log-in	
Settings	General	 NOTICE "Setting" can only be visible in selecting the mode "Ctrl Mode" > "Manual Operate"	
	Advanced	Cabinet Type	
		System	
		HMI	
		AC Info	
		DC Info	
STS	 NOTICE Invisible without STS or other on-grid/off-grid Switching device		
Operation	System Startup	 NOTICE	
	System stop		
	Grid-tied	"Operation" can only be visible in selecting the mode "Ctrl Mode" > "Manual Operate"	
	Off-grid		
	Clear Fault		
Ctrl Mode	Manual Operate	"Settings" can be visible "Operation" can be visible "Tactics" can be visible	
	Automatic Operate	 NOTICE "Settings" invisible "Operation" invisible "Tactics" can be visible	
	Remote control	 NOTICE "Settings" invisible "Operation" invisible "Tactics" invisible	
Tactics	Description		
	Strategy		
	Mountings		

User	Password
------	----------

12.3 Control Mode Setting

Main menu structure can be different in different "Ctrl Mode".

Configuring the control mode

1. Select "User", Log into the control interface on touch screen with password .

2. Select "Ctrl Mode" > "Manual Operate"

"Settings" "Operation" "Ctrl Mode" "Tactics" can be visible.

3. Select "Ctrl Mode" > "Automatic Operate"

"Ctrl Mode" "Tactics" can be visible.

"Settings" "Operation" invisible.

4. Select "Ctrl Mode" > "Remote control"

"Ctrl Mode" can be visible.

"Settings" "Operation" "Tactics" invisible.

12.4 Parameter Setting



NOTICE

"Setting" can only be visible in selecting the mode "Ctrl Mode" > "Manual Operate"

When the system is in "Automatic Operate" or "Remote Control" mode, the settings is invisible and no need to configure.

1. Select "User", Log into the control interface on touch screen with password.

2. Select "Ctrl Mode" > "Manual Operate"

"Settings" can be visible.

12.4.1 Settings Menu

The "Setting" menu including "General" and "Advanced" setting.

The "General" branch menu is shown below.

General	Setting Parameter	Explanation
Active power setting	-770.0~+770.0KW; default 0.0	
Reactive power setting	+:lagging;-:leading; -770.0~+770.0kVar;default 0.0	
DC lower voltage	500.0~850.0 V ;default630.0 for the PWS1 series	
End-of Discharge Voltage	30.00~900.00V; default 300.0	
Topping charge voltage	500.0~850.0 V ;default630.0 for the PWS1 series	
Float charge voltage	500.0~850.0 V ;default630.0 for the PWS1 series	Only for the 1 branch DC input
Topping charge turn to float charge judgment current	0.0~250.0A;default 0.0	
End-of-charge current	0.0~250.0A;default 0.0	
Maximum charge current	0.0~1500.0A;Default 50.0	
Maximum discharge current	0.0~1500.0A;Default 50.0	
Help	Volt-Current Curve and other instruction	

The "Advanced" menu including the "Cabinet Type", "System", "HMI", "AC Info", "DC Info", "STS".



NOTICE

The "STS" menu can only be visible when the system is integrated with the STS module or other switching devices.

The branch menu is shown below.

Advanced	Setting Parameter	
Cabinet Type	Cabinet type	factory setting
	Certification	factory setting
	DC Input Type	factory setting
	Inverter type	factory setting
	Rated frequency	factory setting
	Rated voltage	factory setting
	Rack ID	factory setting
	Working mode	factory setting
	Soft start	factory setting
	Control parameter 3	factory setting
Apply	/	
System		
1	Startup mode	Manual /Auto startup
	Energy dispatching mode	AC /DC dispatching
	DC string setting pattern	ALL/Separate
	Neutral grounding function	Disabled/Enabled
	Control parameter 1	/
	Control parameter 2	/
2	Control parameter4	/
	Control parameter 5	/
	Control parameter 6	/
	Control parameter 7	/
	Charged energy calibration	/
	Discharged energy calibration	/
HMI		
1	System real time	Yyyy-mm-dd-hh-mm-ss
	IP	/
	Gateway	/
	Subnet mask	/
	Modbus address	1~247
	RTU baud rate	19200/9600
	BMS enable	Disabled/Enabled
	Integrated BMS protocol	JUNWEI/NANDU/XIEXIN/XINWANGDA/W OTAI/PAINENG/GAOTE/Other
	Language	English/简体中文
	Reset Settings	/

	Calibrate	/
	Modify MAC	/
2	Illumination timeout (min)	0~120 (min)
	BMS timeout (s)	0~600(s)
	TCP remote timeout (s)	0~600(s)
	485 remote timeout (s)	0~600(s)
	Log interval (min)	/
	104 protocol address	/
AC Info		
1	PF setting	+:lagging, -:leading,m-1.00~+1.00;default 1.00
	Active power setting	-770.0~+770-.kw, default 0.0
	Reactive power setting	+:lagging, -:leading,-770.0~770.0kVar, default 0.0
	Grid recovery delay	0.00~600.00s,default 20s
	Power ramp rate	0.01~2.00/s, default 1.00
	Grid reconnection power ramp rate	0.001~2.000/s, default 0.020
	Off-grid AC Volt regulation	-0.10~+0.10,default 0.00
2	Reactive power control mode	Fixed PF/ Fixed Q/ Volt-Var
	Active Power control mode	Specified P/ Volt-Watt / Freq-Watt/V-Watt&F-Watt
	Island detection enable	Disabled/Enabled
	Power change mode	Step/Ramp rate
	FVRT function	Disabled/Enabled
	FVRT Limit function	Disabled
	Off-grid Volt startup mode	Step/Soft start
3	Over voltage region 1 protection voltage ratio	USA: 1.05~1.25; CHN: 1.05~1.35; Australia: 1.05~1.20; UK: 1.05~1.35; default 1.15
	Over voltage region 1 protection time	USA: 0.01~13.00; CHN: 0.01~13.00; Australia: 0.01~2.00; UK: 0.01~13.00; default 1.00
	Over voltage region 2 protection voltage ratio	USA: 1.05~1.25; CHN: 1.05~1.35; Australia: 1.05~1.25; UK: 1.05~1.35; default 1.20
	Over voltage region 2 protection time	USA: 0.01~2.00; CHN: 0.01~1.00; Australia: 0.01~0.50; UK: 0.01~1.00; default 0.10
	Under voltage region 1 protection voltage ratio	USA: 0.45~0.95; CHN: 0.50~0.85; Australia: 0.50~0.85; UK: 0.45~0.95; " default 0.80
	Under voltage region 1 protection time	USA: 0~21.00; CHN: 0.01~5.00; Australia: 0~5.00; UK: 0.01~5.00; default 2.00

	Under voltage region 2 protection voltage ratio	USA: 0.45~0.95; CHN: 0.20~0.50; Australia: /; UK: 0.45~0.95; default 0.60
	Under voltage region 2 protection time	USA: 0.01~11.00; CHN: 0.01~1.00; Australia: /; UK: 0.01~1.00; default 1.00
	Under voltage region 3 protection voltage ratio	USA: 0.45~0.95; CHN: /; Australia: /; UK: /; default 0.45
	Under voltage region 3 protection time	USA: 0~1.00; CHN: /; Australia: /; UK: /; Default 0.16
4	Over frequency region 1 protection frequency	USA: 0.10~4.50; CHN: 0.10~3.00; Australia: 0.10~3.00; UK: 0.10~3.00; default 0.50
	Over frequency region 1 protection time	USA: 0.01~300.00; CHN: 0.01~300.00; Australia: 0.01~5.00; UK: 0.01~300.00; default 2.00
	Over frequency region 2 protection frequency	USA: 0.10~4.50; CHN: 0.10~3.00; Australia: /; UK: /; default 2.00
	Over frequency region 2 protection time	USA: 0.00~10.00; CHN: 0.00~10.00; Australia: /; UK: 0.00~10.00; default 0.16
	Under frequency region 1 protection frequency	USA: -4.50~ -0.10; CHN: -4.50~ -0.10; Australia: -5.00~ -0.10; UK: -4.50~ -0.10; default -0.50
	Under frequency region 1 protection time	USA: 0.00~600.00; CHN: 0.00~600.00; Australia: 0.01~5.00; UK: 0.00~600.00; default 2.00
	Under frequency region 2 protection frequency	USA: -4.50~ -0.10; CHN: -4.50~ -0.10; Australia: /; UK: -4.50~ -0.10; default -3.00
	Under frequency region 2 protection time	USA: 0.00~10.00; CHN: 0.00~10.00; Australia: /; UK: 0.00~10.00; default 0.16
5	Over voltage region 1 ride-through voltage ratio	USA: 1.10~1.20; CHN: /; Australia: /; UK: /; ,default 1.10
	Over voltage region 1 ride-through until	USA: 0.00~13.00; CHN: /; Australia: /; UK: /; default 12.00
	Over voltage region 2 ride-through voltage ratio	USA: 1.10~1.20; CHN: /; Australia: /; UK: /; default 1.20

	Over voltage region 2 ride-through until	USA: 0.00~0.16; CHN: /; Australia: /; UK: /; default 0.10
	Under voltage region 1 ride-through voltage ratio	USA: 0.50~0.88; CHN: /; Australia: /; UK: /; default 0.80
	Under voltage region 1 ride-through until	USA: 20.00~50.00; CHN: /; Australia: /; UK: /; default 20.00
	Under voltage region 2 ride-through voltage ratio	USA: 0.50~0.88; CHN: /; Australia: /; UK: /; default 0.60
	Under voltage region 2 ride-through until	USA: 10.00~50.00; CHN: /; Australia: /; UK: /; default 10.00
	Under voltage region 3 ride-through voltage ratio	USA: 0.40~0.50; CHN: /; Australia: /; UK: /; default 0.50
	Under voltage region 3 ride-through until	USA: 0.1~21.00; CHN: /; Australia: /; UK: /; default 1.00
6	Over frequency region 1 ride-through frequency	USA: 0.1~6.00; CHN: /; Australia: /; UK: /; default 3.00Hz
	Over frequency region 1 ride-through until	USA: 20.0~1000.0; CHN: /; Australia: /; UK: /; default 299.0
	Over frequency region 2 ride-through frequency	USA: 0.1~6.00; CHN: /; Australia: /; UK: /; default 5.00Hz
	Over frequency region 2 ride-through until	USA: 0.0~1000.0; CHN: /; Australia: /; UK: /; default 0.1
	Under frequency region 1 ride-through frequency	USA: -10~ -0.10; CHN: /; Australia: /; UK: /; default -3.00Hz
	Under frequency region 1 ride-through until	USA: 20.0~1000.0; CHN: /; Australia: /; UK: /; default 299.0
	Under frequency region 2 ride-through frequency	USA: -10~ -0.10; CHN: /; Australia: /; UK: /; default -10.00Hz
	Under frequency region 2 ride-through until	USA: 0.0~1000.0; CHN: /; Australia: /; UK: /; default 0.1
7	Volt/Var regulation Volt point 1	USA: 0.82~1.03; CHN: /; Australia: 0.82~1.03; UK: /; default 0.92
	Volt/Var regulation Volt point 2	USA: 0.90~1.05; CHN: /; Australia: 0.90~1.05; UK: /; default 0.97
	Volt/Var regulation Volt point 3	USA: 0.95~1.15; CHN: /; Australia: 0.95~1.15; UK: /; default 1.03
	Volt/Var regulation Volt point 4	USA: 0.97~1.18; CHN: /; Australia: 0.97~1.18; UK: /; default 1.07
	Volt/Var regulation Q1	USA: 0.00~0.60; CHN: /; Australia: 0.00~0.60; UK: /; default 0.3
	Volt/Var regulation Q2	0~0.6*Q, default 0
	Volt/Var regulation Q3	0~0.6*Q, default 0
	Volt/Var regulation Q4	USA: 0.00~0.60; CHN: /; Australia: 0.00~0.60; UK: /; default 0.3

	Volt/Var response time	1~90s, default 10s
	Volt/Var reference voltage Vref	0.95~1.05, default 1.00
8	Volt/Watt regulation start Volt point (High Volt)	USA: 1.03~1.10; CHN: /; Australia: 1.02~1.11; UK: /; default 1.06
	Volt/Watt regulation end Volt point (High Volt)	1.04~1.10, default 1.10
	Volt/Watt regulation start Power point (High Volt)	0.00~1.00*P, default 1.00
	Volt/Watt regulation end Power point (High Volt)	0.00~1.00*P, default 0.00
	Volt/Watt response time (High Volt)	0.50~60.00s, default 10.00s
	Volt/Watt regulation recovery delay	3.00~90.00s, default 60.00s
	Freq/Watt regulation start Freq point(High Freq)	USA: 0.01~1.00; CHN: /; Australia: 0.01~1.00; UK: /; default 0.05
	Freq/Watt regulation ramp rate	USA: 0.02~0.07; CHN: /; Australia: /; UK: /; default 0.05
	Freq/Watt response time (High Freq)	0.05~3.00s, default 0.50s
DC Info		
1	Select DC String	1
	DC lower voltage	30.0~800.0V, default 300.0
	End-of-discharge voltage	30.0~800.0V, default 300.0
	Topping Charge Voltage	30.0~800.0V, default 500.0
	Float Charge Voltage	30.0~800.0V, default 500.0
	Topping charge turn to float charge judgment current	0.0~250.0A, default 0.0
	End-of-charge current	0.0~1500.0A, default 50.0
	Maximum charge current	0.0~1500.0A, default 50.0
	Maximum discharge current	0.0~1500.0A, default 50.0
	Help	
2	Select DC String	1/4/8
	DC control mode	Const I/Const P
	DC current setting	-1500.0~1500.0A, default 0.1
	DC power setting	-1000.0~1000.0kw,default 0.1
	Start of Discharge Threshold Voltage	30.0~900.0V, default 30.0
	Maximum precharge current	0.0~1500.0A,default 0.0
	Precharge voltage	30.0~900.0V,default 30.0
	Precharge turn to fast charge judgment voltage	1.0~900.0V,default 1.0
	Precharge time	0~30000min,default 0
STS	Controlling Parameter 1	-32768~32767, default 0
	Controlling Parameter 2	-32768~32767, default 0
	Controlling Parameter 3	-32768~32767, default 0
	Grid-tied turn to Off-grid mode	Allowed to set Off-grid / Not allowed to set Off-grid

12.5 Common Setting

12.5.1 Language Selecting

Procedure:

1. Select **"User"**> Input password> **"OK"**>**"Login"**. (Log into the PCS user interface)
2. Select **"Ctrl mode"**> **"Manual Operate"**.
3. Select **"Setting"**> **"Advanced"**> **"HMI"** > **"Language"** >**"English"** or **"简体中文"**.
4. Then a window will pop up to remind you that system will restart, click **"Yes"** or **"OK"**.

12.5.2 Date and Time Selecting

Procedure:

1. Select **"User"**> Input password> **"OK"**>**"Login"**. (Log into the PCS user interface)
2. Select **"Ctrl mode"**> **"Manual Operate"**.
3. Select **"Setting"**> **"Advanced"**>**"HMI"**>**"System real time"**>**"Yyyy-mm-dd-hh-mm-ss"**
4. Then click **"OK"** to save or click **"ESC"** to discard changes.

12.5.3 Communication setting

Procedure:

1. Select **"User"**> Input password> **"OK"**>**"Login"**. (Log into the PCS user interface)
2. Select **"Ctrl mode"**> **"Manual Operate"**.
3. Select **"Setting"**> **"Advanced"**>**"HMI"**>**"IP"** to set the IP of PCS. Enter the static IP address that you want to use to access the PCS.
4. Then click **"OK"** to save or click **"ESC"** to discard changes.
5. To change the gateway IP address of your network, enter the IP address in **"Gateway"**.
6. To change the subnet mask of your network in the field Subnet mask., enter the **"Subnet mask"**.
7. To change the Modbus address of your PCS, enter the **"Modbus address"**.
8. To change the baud rate of MODBUS communication, enter the **"RTU baud rate"**.

12.5.4 AC settings

Procedure:

1. Select **"User"**> Input password> **"OK"**>**"Login"**. (Log into the PCS user interface)
2. Select **"Ctrl mode"**> **"Manual Operate"**.
3. Select **"Setting"**> **"Advanced"**>**"AC Info"**

"PF setting" : set to regulate the PF of the entire storage system

"Active power setting": Set to regulate the power of the storage system

"Reactive power setting": Set to regulate the reactive power of the storage system

"Grid recovery delay": please keep the default configuration.

"Power ramp rate": please keep the default configuration. This function will apply when set power

changes. The default value is 2 rated power per second, which means within 0.5 seconds the system can run to full output.

"Grid reconnection power ramp rate": please keep the default configuration. This function will apply when system suspend happens caused by utility grid voltage abnormal, and reconnect after utility grid restore normal. The default value is 2, twice of rated power per second, which means within 0.5 seconds the system restores to full output.

"Off-grid AC Volt regulation": to regulate the off-grid output voltage.

"Reactive power control mode": to set the operation mode, constant power or constant reactive power.

"Active power control mode": enable or disable active power regulation.

"Island detection enable": enable or disable anti-islanding function. For more information, please refer to UL1741 Supplement A or other similar rules about Utility Grid-Interactive Distribute Generators.

"Power change mode": to set the power change pattern, step-to-top, or ramp-rise.

"Off-grid Volt startup mode": Can be set as step-to-top, or ramp-rise.

12.5.4.1 FVRT

"FVRT function": frequency/voltage ride-through, this function can be enabled or disabled, for more information, please refer to UL1741 Supplement A or other similar rules about Utility Grid-Interactive Distribute Generators.

"Over/Under voltage region 1/2/3 protection voltage ratio": to set the over/under voltage ride through protect voltages.

"Over/Under voltage region 1/2/3 protection time": to set the over/under voltage ride through trip times.

"Over/Under frequency region 1/2/3 protection frequency": to set the over/under frequency ride through protect frequencies.

"Over/Under frequency region 1/2/3 protection time": to set the over/under frequency ride through trip times.

12.5.4.2 Volt/Var

Volt/Var regulation is only available when enabled. In Volt/Var mode, the Q configuration is disabled.

"Volt/Var regulation Volt point 1/2/3/4": to set the Volt/Var switch point.

When the actual voltage between Volt/Var point 1 and 2, the capacitive reactive power will be increased.

When the actual voltage between Volt/Var point 3 and 4, the inductive reactive power will be increased.

For more information, please refer to UL1741 Supplement A or other similar rules about Utility Grid-Interactive Distribute Generators.

"Volt/Var regulation Q1/Q2/Q3/Q4": to set the maximum inductive reactive power regulation. And to set the maximum capacitive reactive power regulation.

12.5.4.3 Volt/Watt

Volt/Watt regulation is only available when activated and operating in discharge mode. When the actual voltage is above the point, the active power will be regulated with the ramp rate. The ramp rate is defined as multiple of set active power per 1% of rated voltage that above the Volt/Watt point.

"Volt/Watt regulation start/end Volt/power point (High Volt)": to set the Volt/Watt trigger threshold.

"Volt/Watt response time (High Volt)": to set the ramp rate when Volt/Watt is triggered.

"Volt/Watt regulation recovery delay": to set the output power restore time delay after the utility grid voltage restores normal.

12.5.4.4 Freq/Watt

Available when activated and operating in discharge mode. When the actual frequency is above the point, the active power will be regulated with the ramp rate. The ramp rate is defined as multiple of set active power per hertz that above the above the Freq/Watt point.

"Freq/Watt regulation start Freq point(High Freq)": to set the Freq/Watt trigger threshold.

"Freq/Watt regulation ramp rate": to set the ramp rate when Freq/Watt is triggered

12.5.5 DC settings

Procedure:

1. Select **"User"**> Input password> **"OK"**>**"Login"**. (Log into the PCS user interface)
2. Select **"Ctrl mode"**> **"Manual Operate"**.
3. Select **"Setting"**> **"Advanced"**>**"DC Info"**

"Battery Under Voltage Threshold": Prioritize the setting according to the manufacturer's recommendation. Conduct setting according to the following data in case of manufacturer's data cannot be obtained:

Set 2V lead battery according to $1.67 \sim 1.80V * \text{number of batteries in series}$;

Set 3.2V lithium batteries according to $2.70 \sim 2.75V * \text{number of batteries in series}$.

"End-of-discharge voltage": Conduct setting according to EOD voltage when there are no special requirements.

"Battery Equal Charge Voltage": Prioritize the setting according to the manufacturer's recommendation. Conduct setting according to the following data when manufacturer's data cannot be obtained: Set 2V lead battery according to $2.20 \sim 2.27V * \text{number of batteries in series}$; set 3.2V lithium batteries according to $3.60 \sim 3.70V * \text{number of batteries in series}$.

"Battery Float Charge Voltage": Prioritize the setting according to the manufacturer's recommendation. Conduct setting according to the following data when manufacturer's data cannot be obtained: Set 2V lead batteries according to $2.20 \sim 2.27V * \text{number of batteries in series}$; set 3.2V lithium batteries according to $3.60 \sim 3.70V * \text{number of batteries in series}$. Keep consistent with the equalizing voltage of battery.

"Topping charge turn to float charge judgment current": Prioritize the setting according to the manufacturer's recommendation. Set 2V lead batteries according to $0.02C \sim 0.05C$ in case of manufacturer's data cannot be obtained. Other connection types can be set as 1A.

"End-of-charge current": keep the default value.

"Maximum charge current": Set 500K as 500A.

"Maximum discharge current": Set 500K as 500A.

"DC control mode": please set it as factory setting between "Const I and Const P".

"DC current setting": Set charging or discharging current within the rated power according to the actual demand. (Available only after "energy dispatching mode" in "system parameter" is set as "DC dispatching", and DC operation mode is set as "constant I mode".)

"DC power setting": Set charging and discharging power within the rated power range according to the

actual demand. (It is valid only after "energy dispatching mode" in "system parameter" is set as "DC dispatching", and DC operation mode is set as "constant P mode".)

"Start of Discharge Threshold Voltage": Conduct setting according to EOD voltage when there are no special requirements.

"Maximum precharge current": Set 500K as 500A.

Conduct setting according to client's requirement. When the client does not require precharge function, set it as 10A.

"Precharge voltage": Conduct setting according to EOD voltage when there are no special requirements.

"Precharge turn to fast charge judgment voltage": Conduct setting according to EOD voltage when there are no special requirements.

"Precharge time": Conduct setting according to client's requirement. When the client does not require precharge function, set it as 1min.

12.5.6 Regulating the reactive power of the ESS AC port in on-grid mode

There are 3 variables in the equation defining power factor:

$$PF = \frac{P}{\sqrt{P^2 + Q^2}}$$

Where

P is active power,

Q is reactive power.

PF is power factor.

If any two of these variables in this equation are determined, the third one is certain. Usually active power is always controlled by the EMS, making several reactive power regulation modes optional

- Constant PF mode, also known as fixed PF mode
- Constant reactive power mode
- Volt-VAr mode
- PF-Watt mode (Australia)

The register for reactive power regulation has 4 modes that could be toggled by demand.

If the inverter is configured into **constant reactive power** mode, the register for regulating **PF** will be ignored by the inverter. The inverter will control its reactive power in accordance with the set reactive power expected value.

Similarly, if the inverter is configured into **constant PF mode**, the register for regulating **System reactive power** will be ignored by the inverter. The inverter will control its **PF** in accordance with the expected **PF** value.

It should be highlighted that the value of PF and reactive power have no sign in electric engineering, but inductive reactive and capacitive reactive power is totally different. To identify the characteristic of the reactive power, the registers and setpoints are defined with signs.

In order to maintain a stable grid voltage, it is desired that inverters be able to supply or absorb reactive power to/from the grid. One way to achieve this is to have the inverter supply or absorb reactive power in response to fluctuations in grid voltage.

HECO RULE 14H/CPUC RULE 21 is requiring all certified grid-support inverters, or smart inverters, shall support a **Volt/VAr** auto-regulation function.

In this mode, the reactive power will be regulated by a curve of reactive power versus grid voltage automatically. The registers or setpoints for regulating **System reactive power** and **PF** will be both ignored by the inverter.

In the applications, there must be a conflict on the active power and reactive power setpoints versus the inverter power capacity.

Say the inverter capacity is 100kVA, and the Volt-VAr mode is activated, the EMS is commanding the active power as 80kW discharging but not regulating the reactive power while the available reactive power ability is 60kVA, according to the equation

Where S is the apparent power rating of the inverter.

At this very time, the grid voltage rises and triggers the Volt-VAr algorithm to be 80kVAr lagging (inductive) reactively.

In each mode The Sinexcel inverter always takes reactive power setpoint higher priority than active power setpoint, if the sum of squares of the P and Q, is higher than the square of kVA rating, the Q rating will be applied, and the P will be conducted as the function of S and Q.

Specifically, in this case, the inverter will reduce the active discharging power from 80kW to 60kW and absorbs 80kVAr inductive reactive power.

12.6 System Setting

Procedure:

1. Select **"User"**> Input password> **"OK"**>**"Login"**. (Log into the PCS user interface)
2. Select **"Ctrl mode"**> **"Manual Operate"**.
3. Select **"Settings"** > **"System"**

"Start up mode": default set **"Manual"**.

"Energy dispatching mode": please set it as **"AC dispatching"**. If **"DC dispatching"** is set according to the actual demand, set **"charging and discharging current"** and **"charging and discharging power"** in **"Settings"**>**"DC Info"** page 2.

"DC string setting pattern": reserved function for special models.

12.6.1 General Setting

Procedure:

1. Select **"User"**> Input password> **"OK"**>**"Login"**. (Log into the PCS user interface)
2. Select **"Ctrl mode"**> **"Manual Operate"**.

3. Select **"Settings"** > **"General"**

Power dispatch including the **"Active power setting"** **"Reactive power setting"**

DC Configuration including the

"DC lower voltage"

"End of Discharge Threshold Voltage"

"Topping charge voltage"

"Float charge voltage"

"Topping charge turn to float charge judgment current"

"End-of-charge current"

"Maximum charge current"

"Maximum discharge current"

12.7 Manual Startup

Check before startup

Before startup, check the device according to the following steps:

- 1) Inspect and ensure that no damage sign is in external part of the module, and DC breaker and AC breaker are at "OFF" position.
- 2) Complete installation according to above Chapter, and check whether DC input wiring and AC output wiring in the PCS are normal, and the grounding is good.
- 3) Check whether battery voltage is normal.
- 4) Check whether phase voltage and wire voltage in utility grid side are in the normal range, and record the voltage.



NOTICE

"Operation" can only be visible in selecting the mode **"Ctrl Mode"** > **"Manual Operate"**

When the system is in **"Automatic Operate"** or **"Remote Control"** mode, the **"Operation"** is invisible and no need to configure.

1. Select **"User"**, Log into the control interface on touch screen with password .

2. Select **"Ctrl Mode"** > **"Manual Operate"**

"Operation" can be visible.

"System Startup" **"System stop"** **"Grid-tied"** **"Off-grid"** **"Clear Fault"** is shown in the **"Operation"** interface.

The system condition will always be and only be in one of the modes between **"Grid-tied"** and **"Off-grid"**.

The system condition will always be and only be in one of the modes between **"System Startup"** and **"System stop"**.

"Clear Fault" is used to clear the faults that can be manually cleared such as "EPO (Emergency Power Off)".

"Clear Fault" can not fit all kinds of faults.

After parameters are set and startup condition is met, machine startup and shutdown can be operated via "System Startup" and "System stop".



NOTICE

After the system start up, check the **"Info"** to know the system working condition.

12.8 Automatic startup

1. Select **"User"**, Log into the control interface on touch screen with password.
2. Select **"Ctrl Mode"** > **"Automatic Operate"**

In automatic startup, the PCS will automatically inspect and judge startup conditions. If the system function is normal and it meets the system setting conditions, it will start automatically. If the voltage of utility grid is too low or high, the frequency is abnormal, DC voltage is too low or high, the PCS will make an alarm, shut down automatically and stop providing power outside.

After meeting the following conditions, the storage inverter will restart automatically, and the output is recovered.

1. DC voltage is normal.
2. The voltage of utility grid is normal in on-grid mode, or there is no voltage of utility grid in off-grid mode.
3. Operation mode setting is correct.
4. There is no other alarm fault.

If automatic startup is not set in storage inverter, users can start the device by hands through touch panel.

12.9 Remote startup

These startup steps are applicable to the circumstance that the storage inverter system is in outage state and can be started. Operation steps are as follows:

- 1) Close output switch of battery rack and connect power supply to DC port of the device.
- 2) Close DC breaker. Green indicator light flickers in green. After about 10s, the red indicator light is always on in red. At this moment, THE HMI will indicate the warning information such as "under-voltage of grid" and "abnormal grid frequency". If step 2 and step 3 are conducted before the red light is always on, the flickering in red will not appear.
- 3) Set monitoring parameter to control operation mode
- 4) Select **"Ctrl Mode"** > **"Remote Control"** and then with other control equipment to start the PCS remotely.
- 5) After step 4 is conducted, return to "main wiring diagram" on THE HMI and the PCS start DC/AC modules.

12.10 Shutdown procedure

During normal operation of storage inverter, the following steps can be conducted if shutdown is required.

- 1) Select **"Ctrl Mode"** > **"Remote Control"** and then with other control equipment to stop the PCS remotely.

Or Select **"Ctrl Mode"** > **"Manual Operate"**; **"Operation"** > **"System Stop"** to manually stop the PCS.

12.11 System Power Off

When PCS is in "System stop" mode, can cut off the DC and AC power and power off the system

- 1): Manually or remote control the system stop.

- 2): Disconnect the AC switch.
- 3): Disconnect the Battery DC switch.

As for above operation process, it has been shut down after step 1 is conducted. The power components stop operating in system, and BUS bar and auxiliary power supply in system still exist for a long time. Therefore, relevant control system is still in standby state. In this state, device setting and maintenance are not allowed. After power off, the storage inverter is in a shutdown state, and the internal connector bars are electrically neutral in system. After the internal capacitance in modules fully discharges, relevant maintenance and setting can be conducted.

12.12 Emergency shutdown

When the storage inverter system is abnormal, press the emergency shutdown button "EPO" on the rack door and the PCS will instantly stop running.



WARNING

To prevent personal injury, please use a multi-meter to measure the voltage at input terminal if case maintenance or opening is conducted. After ensuring that there is no mains supply, relevant operation can be conducted!

After about 15 minutes, the upper cover plate can be opened after DC BUS bar capacitance fully discharges (refer to warning label on module case surface).

Appendix 2 Limited Warranty Policy

Shenzhen Sinexcel Electric Co. Ltd and its subsidiaries (“**SINEXCEL**”) support the products manufactured with warranties that differ depending on the product, market segment, operating conditions, and other factors.

This warranty letter (“**Warranty Letter**”) explains the limited warranty for the bi-directional PCS and/or the pre-engineered battery energy storage systems (“**Product**”) described in the product specifications sheet attached with each product shipped (“**Specifications**”).

SINEXCEL warrants that, during the Warranty Period (see definition below), the Products supplied hereunder shall be free from defects in material and workmanship and meet the **Specifications** subject to the terms and conditions below (“**Warranty**”).

1. **SINEXCEL** purchases parts and sub-systems from multiple component suppliers to build up its **Product**. These component suppliers may include but are not limited to IGBT module and/or other electronic component suppliers, enclosure and container suppliers, rack suppliers and fire protection system suppliers. Sinexcel is just responsible for managing the warranties involved with these subsystems. Part supplier and sub-system warranties will not be transferred to **the Buyer**, unless separately specified, as the entire system is warranted under this **Warranty Letter**.
2. Operating Conditions - Specific operating conditions and limitations are described in the **Specifications**. These operating conditions are requirements by Sinexcel and any operation of the Product outside the conditions listed in the Specifications voids the Warranty. Specific conditions that are important to the operation of the Product include, but are not limited to, storage and operating environment, maximum charge and discharge current and voltages, and state of charge operation. The specifications of goods designed by SINEXCEL may be modified, provided that the modifications do not adversely affect the performance of the goods.

It is the responsibility of the customer to maintain records and operational data that must be presented to **SINEXCEL** upon a Warranty claim demonstrating that the **Product** has been operated within its specified operating conditions.

It is the responsibility of the customer to control any component or design provided by a third party other than **SINEXCEL**, provided that such third party is not determined or recommended in writing by **SINEXCEL**.

3. Warranty Period – **SINEXCEL** warrants to the customer that the **Product** will be free from defects in material, if operated within the operating conditions listed in the Specification, for a period of three [3] years from the date of the Factory Acceptance Test (or shipment date) (**Warranty Period**). Extension of **Warranty Period** could be purchased by the customer before shipping from **SINEXCEL**.

4. Filing Procedures – If a Warranty claim need to be filed, please contact **SINEXCEL** by email or phone call soonest.
5. Right To Cure – If the Product falls below its performance Specifications or otherwise fails to meet the requirements listed in the **Specifications** within **Warranty Period**, then **SINEXCEL** has the right to remedy the problem by either repairing the **Product** or replacing the **Product**. Repair or replacement of any **Product** under warranty shall not be deemed to serve to extend the original warranty period.
6. Inspections, Acceptance, Rejection – The Buyer is encouraged to inspect the Product prior to shipment. Inspections shall be made by the Buyer within 10 days of receiving the written notice that the product will be ready for inspection. During the inspection, the Buyer will take all precautions so as to not interfere with Seller’s employees or work operations during the visit. All information gained during inspections is deemed “**confidential**” and can only be used for enforcement of the terms of this Agreement. If the Product is not inspected prior to shipment, the Product must be inspected by the Buyer within 15 days of signature of delivery receipt and either accepted, rejected, or conditionally accepted. If the Product is conditionally accepted, specific actions that must be taken to reach acceptance shall be documented and provided to Sinexcel soonest. **The warranty does not cover the damage during shipment**, which may be covered by extra paid warranty after written approval by Sinexcel.
7. Tampering – If the **Product** is in any way tampered with, the Warranty is void and not applicable. The PCS modules may not be opened; the firmware may not be reprogrammed, etc. The **Warranty** is also void and not applicable as to Products and/or any products manufactured or integrated by Buyer which contain the Products which are determined by **SINEXCEL** to have been subjected to abuse, mishandle, misuse, negligence, accident or faulty repair of the Products by any unauthorized Personal/Party after receipt of the Products.
8. Out-of-warranty Service- After the Warranty Period, **SINEXCEL** may choose to repair or replace any malfunction **Product** at prices which shall be mutually agreed.
9. Limitation of Damages - In no event, shall **SINEXCEL** be liable to customer or any third party for lost profits, or loss of use, or for incidental, consequential or special damages, arising out of or related to the purchase, installation, use or performance of **Product** or any default of **SINEXCEL** under terms and conditions of sales contract.
10. Acts of God – The Warranty does not apply in the event of any inevitable or unpredictable event beyond the control of **SINEXCEL** causes any failure in the use, operation or meeting the **Specifications** of the **Products** delivered.
11. Limited Warranty - The limited warranty covers only those direct defects that arise as a result of normal use of the **Product** and does not cover any other problems, including but not limited to those that arise as a result of: (1) compliance with the customer’s designs,

specifications, requirements or instructions; or (2) repair, modification, alternation or disassemble not by **SINEXCEL**; or (3) combination to other stuff not manufactured by **SINEXCEL**; or (4) normal or usual deterioration; or (5) customer's abuse; or (6) the usage beyond the **Product**'s general or intended use; or (7) out-of-specification usage; or (8) improper operation; or (9) improper working condition or storage environment; or (10) force majeure; or (11) any factor not attributable to **SINEXCEL**.

12. Software - **SINEXCEL**'s limited warranty applies only to a failure to execute programming instructions. **SINEXCEL** does not warrant that the operation of any Product will be uninterrupted or error free.

13. This warranty is instead of all other warranties expressed or implied, including but not limited to, the implied warranties of merchantability and fitness of a purpose and for all other obligations or liability on **SINEXCEL**'s part. **SINEXCEL** neither assumes nor authorizes any other person to assume for sell any other liability in connection with the sale of **Products**, unless written described on other contracts.

Moreover, in no event shall **SINEXCEL** or its suppliers be liable for indirect, incidental, consequential or special damages, whether based on contract, tort, or any other legal theory and whether advised of the possibility of such damages.

14. **SINEXCEL** may provide technical, applications or design advise, quality or characterization and reliability data, or service in connection with sales contract. Providing these items shall not expand or otherwise affect **SINEXCEL** warranty of warranty liability set forth above and no obligation or liability shall arise from the provision of such items by **SINEXCEL** unless separate defined in other contract.

15. **SINEXCEL**'s Limited Warranty Statement is valid in any country where the covered **SINEXCEL** product is distributed by **SINEXCEL**. Contracts for additional warranty services, such as on-site service, may be available from any authorized **SINEXCEL** service facility in countries where the product is distributed by **SINEXCEL** or by an authorized importer.

16. To the extent allowed by local law, the remedies provided in this Limited Warranty Statement are the customer's sole and exclusive remedies.

The Buyer agree and confirm above mentioned all clauses of this Limited Warranty Policy.

Signature confirmation of the Buyer:

Date: